

Telonics TCA-500C Combos, Mini-Combos, Head Unit, Preamplifier and External Speakers

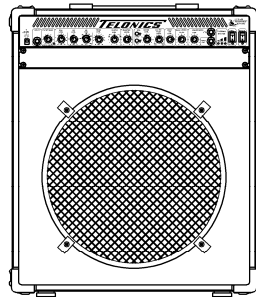

**TCA-500C
15-1U COMBO**

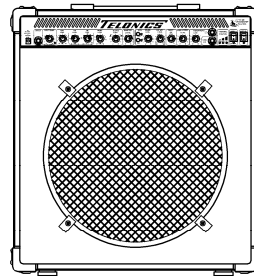

**TCA-500C
15-MINI COMBO**

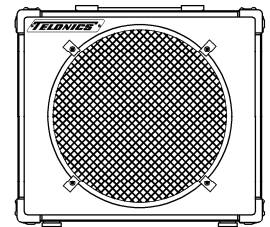

**MINI-15 EXTERNAL
SPEAKER ENCLOSURE**

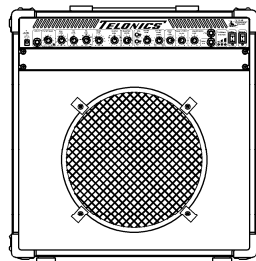

**TCA-500C
12-1U COMBO**

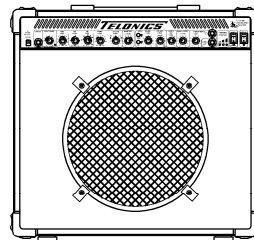

**TCA-500C
12-MINI COMBO**

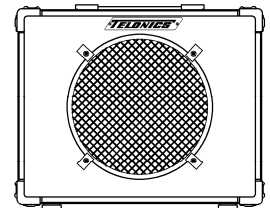

**MINI-12 EXTERNAL
SPEAKER ENCLOSURE**



**TCA-500C-1U
HEAD UNIT**

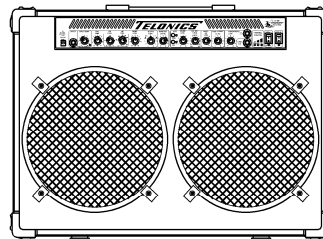

**TCA-500C 212
SUPER TWIN COMBO**



**TLF-PRE500
LITE-FLIGHT
PREAMPLIFIER
SYSTEM**



932 E Impala Ave
Mesa, AZ 85204-6699 USA
(480) 892-4444 Fax (480) 892-9139

email: proaudioinfo@telonics.com

IMPORTANT SAFETY INFORMATION



CAUTION: Risks of electrical shock – **DO NOT OPEN**

CAUTION: To reduce the risk of electric shock, do not remove from cabinet. No user serviceable parts inside. Refer Servicing to Telonics service personnel.

WARNING To prevent electrical shock or fire hazard, do not expose this appliance to rain or moisture. Before using appliance, read the operating guide for further warnings.

WARNING: ** HIGH SOUND LEVELS CAN IRRIVERSEABLY DAMAGE YOUR HEARING **

A single brief exposure to a high noise level can permanently damage your hearing. Hearing damage can also occur gradually at much lower noise levels, if there is enough exposure over time. Evidence suggests the risk of damage to hearing occurs when the level exceeds 85dB. An example of 80dB might be an alarm clock and 90dB a lawn mower. Current evidence suggests ears can tolerate up to 2 hours of exposure at 91dB, but damage can occur with only 1 minute of exposure at 112dB. Levels of 110dB on a bandstand are frequently recorded. Whenever you use this apparatus carefully evaluate the sound level. In a band situation **ALWAYS PROTECT YOUR HEARING**. Note excessive headphone and in-ear monitor levels can also damage hearing. Carefully evaluate and minimize the level when using the headphone output.

- Do not operate near heat sources, such as radiators.
- Protect cords from being walked on or pinched.
- Do not use the apparatus with a damaged or frayed lead.
- Unplug this apparatus during lightning storms.
- Unplug this apparatus when unused for long periods of time.
- No naked flame sources should be placed on the apparatus.

EXPLANATION OF GRAPHICAL SYMBOLS:

EXPLICACION DE SIMBOLOS GRAFICOS:

EXPLICATION DES SYMBOLES GRAPHIQUES:



=

"DANGEROUS VOLTAGE"

"VOLTAJE PELIGROSO"

"DANGER HAUTE TENSION"



=

"IT IS NECESSARY FOR THE USER TO REFER TO THE INSTRUCTION MANUAL"

"ES NECESARIO QUE EL USUARIO SE REFIERA AL MANUAL DE INSTRUCCIONES"

"REFERREZ-VOUS AU MANUAL D'UTILISATION"



Correct disposal of this product: This symbol indicates that this product should not be disposed of with your household waste, according to the WEEE directive (2002/96/EC) and your national law. This product should be handed over to an authorized collection site for recycling waste electrical and electronic equipment (EEE). Improper handling of this type of waste could have a possible negative impact on the environment and human health due to potentially hazardous substances that are generally associated with EEE. At the same time, your cooperation in the correct disposal of this product will contribute to the effective usage of natural resources. For more information about where you can drop off your waste equipment for recycling, please contact your local city office, waste authority, or your household waste disposal service.

TABLE OF CONTENTS

<i>Important Safety Information</i>	2
<i>Table of Contents</i>	3
<i>Electromagnetic Compatibility & Warranty</i>	4
<i>Introduction</i>	5
<i>Front Panel</i>	7
<i>Rear Panel</i>	22
<i>TCA-500C 15” Mini-Combo (Internal Speaker) Amp Control Functions</i>	32
<i>TCA-500C 12” Mini-Combos (With External Speaker) Amp Control Functions</i>	33
<i>TCA-500C Head Unit (only) Amp CONTROLS Functions & Jacks</i> ...	34
<i>TCA-500C Combo Amp Setup Settings:</i>	35
<i>TCA-500C Thermal Management System</i>	37
<i>Frequently Asked Questions</i>	39
<i>(Optional) External Control Units</i>	41
<i>Handy Patch MIDI Controller MC100</i>	43
<i>Using Small “Stomp Box” Effects Units with the TCA-500 series Amplifiers</i>	46
<i>How To Be A Tone Master – Subtractive Equalization</i>	48
<i>Telonics Tilt-Back Foot</i>	50
<i>Mechanical Data</i>	51
<i>Electrical Data</i>	52
<i>Mechanical Outline Drawings</i>	53

Electromagnetic Compatibility & Warranty

EMC/EMI

This equipment has been assessed for radiated and conducted emissions compliance with reference to FCC Part 15 Class B and EN61000-6-3 standards and found to comply with the limits.

This device complies with Part 15 of the FCC Rules. Operation is subject to the following two conditions:

- (1) This device may not cause harmful interference, and
- (2) This device must accept any interference received, including interference that may cause undesired operation.

This device complies with Canadian Interference regulations CAN ICES-3(B)/NMB-3(B).

Note: These limits are designed to provide reasonable protection against harmful interference in a residential environment. This equipment generates, uses, and can radiate radio frequency energy and, if not installed and used in accordance with the instructions, may cause harmful interference to radio communications. However, there is no guarantee that interference will not occur in a particular installation. If this equipment does cause harmful interference to radio or television reception, which can be determined by turning the equipment (including the PSU), off and on, the user is encouraged to try correcting the interference by one or more of the following measures:

- *Reorient or relocate the receiving antenna.*
- *Increase the separation between equipment and the receiver.*
- *Connect the equipment PSU to an outlet on a circuit different from the one to which the receiver is connected.*
- *Consult the dealer or an experienced radio/TV technician for help.*

CAUTION: All warranties and certifications are null and void if this equipment is opened and tampered with in any way.

Warranty

We warrant this product to be free of defects in materials or workmanship for a period of one year after delivery to the original purchaser. Our obligation under this warranty is limited to the replacement or repair of any part or parts which prove upon our examination to be defective. This warranty does not apply to damage resulting from transportation, misuse, abuse, or alteration.

INTRODUCTION OF THE TELONICS TCA-500C



FRONT PANEL (COLOR LABEL OPTION SHOWN)

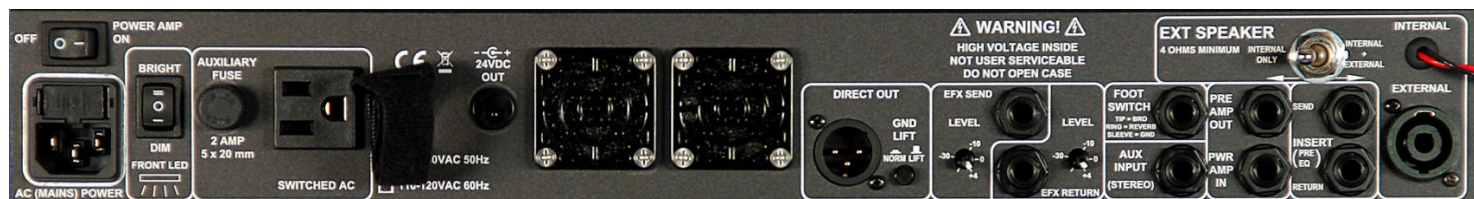

REAR PANEL

Congratulations on purchasing one of the world's finest professional instrument combo amplifiers! The TCA-500C combo amplifier is a state of the art audiophile quality unit designed and built with the latest and best sounding technologies. It has been carefully engineered to provide every function and convenience possible within its cost/benefit ratio, for the professional musician. There is a reason for every function provided. The user is encouraged to read this manual in order to achieve the highest level of performance provided by these capabilities.

The TCA-500C combo amplifier gives you dramatically better control of your sound. The result is transparent smooth clean sound, tight bottom end and silky highs. It is designed to accommodate many different instruments and as such, its controls cover a wider range of options than previously offered to the professional musician. Accordingly, for any given instrument, the controls may 'feel' more sensitive when adjusted for a specific instrument. For this reason, the user is encouraged to make smaller adjustments while listening carefully. Final adjustments should always be made with the ear, without regard to where one "expects" the knob to be.

Telonics TCA-500C Combo Amp Features:

- Superb string separation at all volume levels. No muddiness!
- All pure analog, main signal chain. No digitization of your sound thru A/D or D/A converters.
- Pre EQ Insert for EQ or 3-wire Pot Pedal hook-up.
- Warm tube-like, even-order harmonic sound with crystal clear highs.
- Ultra low noise – studio quality.
- Exceptionally high headroom.
- High output level available on demand.
- 500 Watt Power Amp section.
- Studio Pre-EQ parallel effects loop with adjustable SEND and RETURN levels to accommodate any EFX unit(s) (rear panel mounted).
- Built in reverb with front panel level control and remote control jack.

***TELONICS TCA-500C COMBO AMP FEATURES:
(CONTINUED)***

- Overload LED indicator.
- Master Wet/Dry fader control – controls internal effects and parallel EFX loop.
- Built-in “TBro” effect with remote control jack.
- Pedal Switch jack on rear panel allows switching “TBro” and Reverb remotely.
- Special “Blend” EQ control for personalizing your tone or adjusting for venue. (Once properly adjusted, Master volume and Blend are generally the only adjustments used).
- Auxiliary AC power outlet, switched with main power switch.

- Special Power On/Off circuit to minimize “pops” and speaker damage.
- Built in high output headphone amp with separate volume control.
- Super quiet Mute circuit with LED indicator.

- Digital Thermal Management System.

- 24 volt DC jack on front panel to power Telonics 24 VDC FP-100 foot pedal.

- 24 VDC or 9 VDC auxiliary power socket option on rear panel to power external effects units (9 VDC on Mini-Combo Models).
- Balanced XLR Direct output for stage and studio use. Includes ground lift switch.
- Analog modeling for Direct Out for live venue or studio use, with preset modeling.
- Buffered tuner output (front panel) - active full-time, even when mute is ON.
- Auxiliary stereo input (on rear panel) for home practice or solo gigs with front panel level control. For CD/mp3 players or for use as a second effects RETURN. Also routed to DI for recording.
- Rear Mounted Power Amplifier On/Off switch for preamp-only use in Studio.
- Highest Quality Telonics NEO Speaker (12 or 15 inch).
- 1U rack space provided which may be used for EFX Units, tuners, etc.
- Built-in cabinet-wide LED lighting for low light venues with back panel switch to control On/Off and brightness level.
- Telonics designed Tilt-Back Foot for ease of viewing and access to controls
- Highly abrasion-resistant outer surface, durable Baltic Birch plywood construction throughout. Made for years of trouble free use.
- International versions available for export that comply with CE and RoHS directives.
- Proudly made in the U.S.A. by musicians and engineers.

**TCA-500C COMBO AMP CONTROL FUNCTIONS, JACKS, & INDICATORS:
FRONT PANEL**

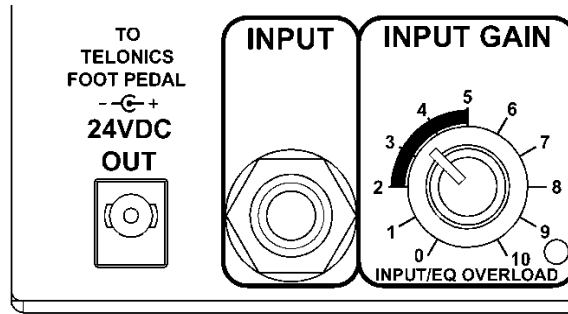
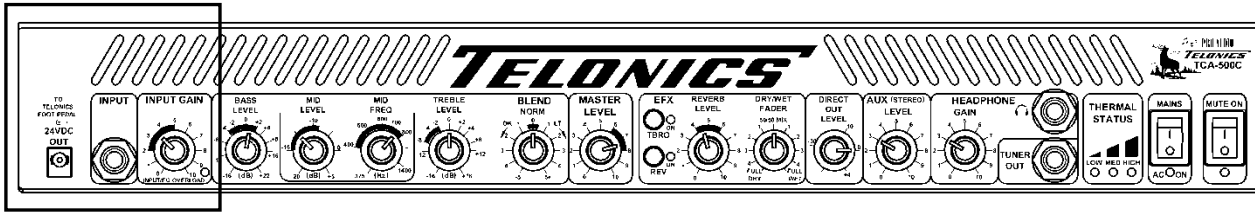

24VDC Output	This socket provides an isolated 24 volts DC to power up the FP-100 foot pedal. It accepts a special twist lock plug for a secure connection of power to the pedal. A power lead with locking connectors is supplied with the TCA-500C Amplifier.
Input	High impedance (1Meg Ohm) instrument input - will not load down your guitar pickup or adversely affect your tone. It accepts a standard 1/4 inch type TS (Tip and Sleeve) Mono plug for guitar level signals.
NOTE:	Prior to adjusting the following controls it is best to start out with the EQ controls flat. Check to see that the Bass, Mid Level, Treble, Blend, and Dry/Wet controls are at zero (0).
Input Gain and Red Overload LED	<p>This control sets the gain for the first amplification stage. And is used in conjunction with the MASTER LEVEL control, it also affects the level for the Insert (Pre EQ) “Send” jack and the maximum level to the EFX Send jack (both of which are on the rear panel). Start at 3 or 4 and adjust as needed.</p> <p>It’s important to understand the function of this control as its setting impacts other controls and the overall sound. When a guitar signal is fed into the amplifier, it is necessary to increase the signal level to minimise noise that might be added in the following stages. Typically, guitar pickups with a high output require a lower gain setting and pickups with a low output required a higher gain setting.</p> <p>In the lower right-hand corner of the Input Gain box is a red (Input/EQ Overload) LED that indicates when an overload is occurring in the pre-amplifier stage. If this LED flashes on frequently, or stays on while the guitar is played, the Input Gain setting is too high and should be reduced in order to avoid distortion of your sound.</p>

**TCA-500C COMBO AMP CONTROL FUNCTIONS, JACKS, & INDICATORS:
FRONT PANEL (CONTINUED)**

<p>Input Gain and Red Overload LED (continued)</p>	<p>The following text describes how the Input Gain should be set with a typical arrangement:</p> <ul style="list-style-type: none"> i) We assume that in most cases, the output of your guitar connects to your volume pedal input and the output of your volume pedal connects to your amplifier <i>(Note; always use good quality leads for these connections and try to ensure they're no longer than they need to be to reach the jacks. Make sure they are not a trip hazard).</i> ii) With the Master Level control set to 1, your volume pedal set to maximum and Input Gain control set to 1, play some nice big chord groups slightly harder than you would normally play; slowly increase the Input Gain control until the Overload LED just starts to occasionally flash, then reduce the Input Gain control until it 'just' ceases to flash as you strike the chords. iii) You have now set the optimum level for the Input Gain control. You should not need to adjust the Input Gain control unless you change your guitar or volume pedal. We suggest you note this setting. <p>A common mistake is to see players using the Input Gain to control output volume. The problem with this is the Input Gain control affects the level sent to the effects unit, so once adjusted as outlined above, it need not be moved. Use the Master Level control to adjust the amplifier volume as needed.</p> <p>Always use the Master Level to control output volume after the Input Gain control has been adjusted as outlined above.</p>
---	--

NOTE: For the best EQ result, make sure the Blend control is at zero (0) while adjusting the Bass, Mid, and Treble tone controls.

TCA-500C COMBO AMP CONTROL FUNCTIONS, JACKS, & INDICATORS: FRONT PANEL (CONTINUED)

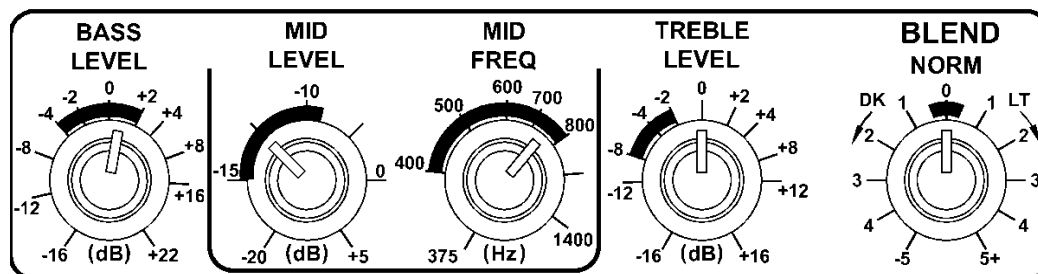
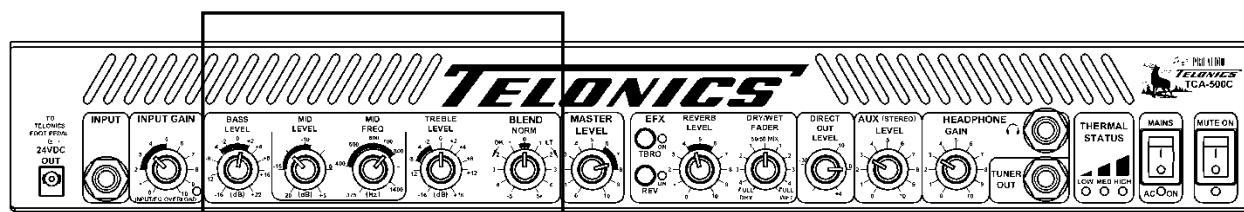

(Note: See pages 33 and 34 for common settings.)

Bass Level	<p>Controls low frequency response. Turning clockwise will boost the bass up to +22dB. Turning counterclockwise will decrease the level down to -16dB. Start at 0 (flat) and adjust to taste.</p> <p>Note that it is a common error to boost the bass excessively, as this dulls the character of the strings. Remember that it is always best to use “Subtractive Equalization” as discussed later in this manual. i.e., instead of boosting the Bass, reduce the Mids and/or Treble. A simple check for excessive bass boost is to listen closely as you strike a lower string repeatedly. Start with the Bass Level control set at -4 or -5. While listening to the character of the string, advance the Bass Level control slowly clockwise. At some point (usually around +1 to +3, the character of the sound will change and will sound like more of a “thud” and have a muted quality. For most people, that is too much bass boost, so back off the control counterclockwise slightly until the sound is once again clear and clean.</p>
Mid Level	<p>It is necessary that the user understand that the Mid Level and Mid Frequency controls work ‘together’. These two controls are used together to set up the mid-range frequency shaping; they are perhaps the most important tone shaping controls and they ‘must’ be set properly to achieve a balanced sound. These controls allow the player to compensate for the ear’s normal increase in sensitivity to mid-range frequencies and the guitar’s resonance around those frequencies.</p> <p>The Mid Level control determines the amount of effect which the Mid Frequency control has on your sound.</p> <p>It sets a boost or cut in the mid-range frequencies, which are selected by the Mid Frequency control. Mid Level is adjustable from -20dB cut to +5dB boost.</p> <p>If you were to set the Mid Level control to Zero dB (3 o’clock knob position), the Mid Frequency control would ‘do nothing whatsoever’ to your sound, it would have NO effect on your tone.</p>

**TCA-500C COMBO AMP CONTROL FUNCTIONS, JACKS, & INDICATORS:
FRONT PANEL (CONTINUED)**

<p>Mid Level (continued)</p>	<p>Since the mid-range frequencies are tiring to the human ear, it is almost always necessary to CUT or reduce them. The Mid Frequency control allows the user to choose the center frequency at which the mid frequencies are reduced, to suit his or her ear.</p> <p>The following text describes how the Mid Level and Mid Freq controls should be set for steel guitar:</p> <ul style="list-style-type: none"> i) We assume the Input Gain control has already been set. Set the Bass Level control to 0, the Treble Level control to 0, the Blend control to 0 and the Master Level control to 2. All effects should be OFF. ii) Now set the Mid Level control fully clockwise (+5) and set the Mid Freq midway (600 Hz). Note when you pick a string the Overload LED may flash; don't adjust the Input Gain control. Note that the overload monitoring circuitry monitors both the output of the gain section and the EQ section; because we've set the Mid Level control to full boost it causes the overload. iii) Ensure the combo speaker is pointed towards your ear. Pick one or two strings in the center string grips and slide the bar over the normal range of the fret board you would use. As you are doing this, tweak the Mid Freq control up and down around the 400 to 800 region; it's handy to have a friend rotate the Mid Freq control as you play. At one point over the region you might possibly notice, no matter where you are on the fretboard, a 'honky' midrange sound is heard that's a little unpleasant on the ear. It does take practice and time to learn how to detect this point, so don't be concerned if it's not clear the first time you attempt this. Note the Overload LED may help detect this point, quite often it flashes more as you hit area's where's there's more resonance. <p>Once you have found the honky, excessive 'middle' sounding frequency, rotate the Mid Level control to around the 10 o'clock position (-12dB). As you play your guitar tweak the Mid Level control up and down around this point until it sounds balanced in the mid-range. Generally, the most suitable setting is between -15 dB and -12 dB for most people. Don't worry about setting the bass and treble controls until you're happy that the mid-range is the best it can be.</p> <p>Always, Always, make the above adjustments with the Bass and Treble controls at zero.</p>
<p>Mid Frequency</p>	<p>Sets the frequency at which the Mid Level control has an effect. Several frequency intervals between 375 Hz and 1400 Hz are marked. Its effect is determined by the setting of the Mid Level control. Proper adjustment is achieved as outlined above.</p>

**TCA-500C COMBO AMP CONTROL FUNCTIONS, JACKS, & INDICATORS:
FRONT PANEL (CONTINUED)**

Treble Level	<p>Adjusts the high frequency level of the sound generated by your instrument. Start at 0 (flat) and adjust to taste. Turning clockwise boosts the level of highs up to +16dB, turning counterclockwise cuts the level of highs down to -16dB.</p> <p>Note: We always recommend using the minimum amount of Bass and Treble tone shaping to achieve the sound you desire. These controls are very powerful; they can greatly cut or boost the gain of the lower and higher frequencies. If an extreme setting of this control is required to achieve a balanced sound you may have an issue with your Mid Level and Mid Frequency control settings, or with your guitar pickup, leads & volume pedal.</p> <p>After setting the Bass Level, Mid Level, Mid Freq and Treble Level controls we suggest you note the settings.</p>
Blend	<p>As indicated earlier this control should be at zero (0) while setting the EQ. Only set this control after you have set all the other tone controls.</p> <p>This is to be used as a sonic “shading” control and, like any seasoning, a little goes a long way. Start at 12 o’clock. Clockwise yields a “Mooney” bright aggressive sound; counterclockwise gives you a mellow, darker tone.</p> <p>The Blend control is initially one of the most confusing settings to understand... until you start using it. After using the combo for a few gigs you may find it’s the only tone control you need! Once the bass, mid and treble controls have been set the amplifier might be considered as calibrated to your style and guitar sound.</p> <p>As you rotate the Blend control clockwise you’ll notice the treble increases and the bass decreases. As you rotate the Blend control counterclockwise you’ll notice the treble decreases and the bass increases.</p> <p>This control is like a ‘one stop shop’ compensating for the affect the room acoustics has on the overall sound. It’s quite remarkable how a small tweak of this control can sweeten up your sound in a live performance situation. And being a single control it’s easy to remember where you started before you started tweaking.</p> <p>Normally, players leave this control at zero and only adjust it slightly between +1 and -1 to compensate for the venue (room size, crowd size, bandstand configuration (even for relative humidity changes, as sound propagates differently with humidity changes).</p>

NOTE: See the TCA-500C Combo Amp Setup Settings section for starting values for different types of settings.

**TCA-500C COMBO AMP CONTROL FUNCTIONS, JACKS, & INDICATORS:
FRONT PANEL (CONTINUED)**

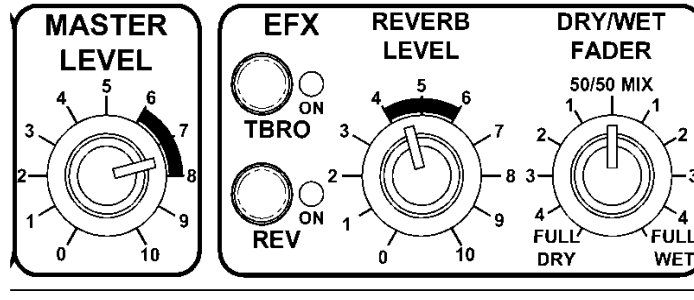
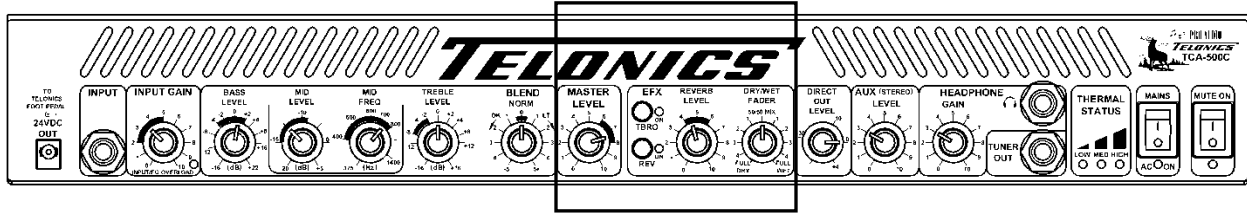

Master Level	<p>Sets the overall output level of the Combo Amp. Adjust this after you have set the Input Gain and EQ. This is your main volume control knob – to be adjusted as necessary as you play a gig. For normal size venues, the customary range is between 6 and 8 or less.</p> <p>The Master Level control sets the overall signal level sent to the power amplifier (PA). Adjustment of this control will not affect the Direct Out level. This allows players to adjust their own stage level without affecting the signal level sent to the mixing desk – a handy feature!</p>
TBRO	<p>This push button switch will activate a “TBro” type effect. The green “TBro” ‘ON’ LED will light when TBro is active. The Foot Switch connector on the rear panel can be used to turn the TBro function Off and On if the TBRO pushbutton switch on the front panel is pushed On (in). If either this switch or an external switch is in the Off position, the effect will remain Off. (When an external/remote switch is not used, the default is On. (See back panel Foot Switch)</p> <p>An optional remote switch box for steel guitar (and a remote foot switch for other instruments) is available for rapid remote control of the TBro and Reverb functions. The usage of these optional accessories is outlined later in this manual.</p>
Reverb Level – Rev ON button	<p>The Reverb Level control determines how much of the internal reverb signal is applied to the Wet/Dry Fader control. The input level to the reverb circuit is affected by the Input Gain control level (as mentioned earlier). The reverb input is a combination of the dry input after the EQ controls and the Post EQ EFX Return signal (rear panel).</p>

**TCA-500C COMBO AMP CONTROL FUNCTIONS, JACKS, & INDICATORS:
FRONT PANEL (CONTINUED)**

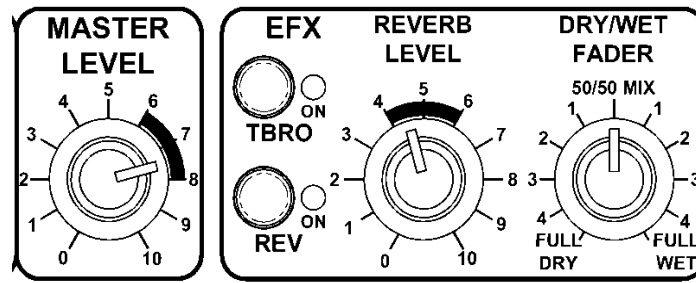

**Reverb Level –
Rev ON button
(continued)**

The Rev push button switch will activate the internal reverb circuit. The green LED will light when the reverb is active. The **Foot Switch** connector on the rear panel can be used to turn the internal reverb Off and On if the **Rev** pushbutton switch on the front panel is pushed On (in). If either this switch, or an external switch, is in the Off position, the reverb will remain Off. When an external remote switch is not used, the default is On. (See back panel Foot Switch)

The built-in reverb is useful if you don't have an effect processor installed. It can be switched On/Off from the front panel using the Rev ON button or by remote control using the Footswitch jack on the rear panel. The reverb sound has been preset to a general ambience algorithm; the Reverb Level control adjusts the amount of reverb introduced.

The built-in reverb signal is added to the signal returning from the EFX Return jack that feeds the Wet side of the DRY/WET Fader. This means, the DRY/WET Fader must have a proportion of Wet signal set or the built-in reverb will not be heard. I.e. if the DRY/WET Fader is set fully Dry no reverb will be heard.

If the TCA-500C is used with a 19" rack effects processor, (such as a Lexicon MX-200, a T.C. Electronics G-Major/II, or other 1U space multi-effects unit), we would recommend the built-in reverb be turned off and patches set up on the effects processor; the reverb algorithms of a good quality effects processor should be superior to the built-in reverb.

1U 19" Rack Space – (Note: The 1U Rack Space is not available on the Mini-Combo units.) The TCA-500C has a built in rack space below the main amplifier chassis. If no effects processor is installed in this space a blanking plate should be installed. On the rear panel a mains switched outlet is provided to power up the effects processor; 50W max. Although the general thought behind providing this space is to enhance the reverb and delay effects, almost any 1U unit no more than 8 inches or 200mm deep could be installed in this space.

**TCA-500C COMBO AMP CONTROL FUNCTIONS, JACKS, & INDICATORS:
FRONT PANEL (CONTINUED)**

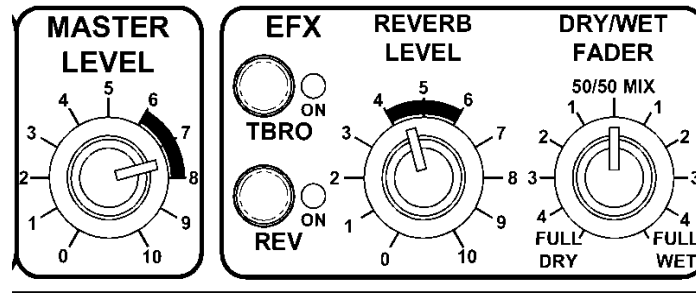

<p>Reverb Level – Rev ON button (continued)</p>	<p>An optional remote switch box for steel guitar (and a remote foot switch for other instruments) is available for rapid remote control of the TBro and Reverb functions. The usage of these optional accessories is outlined later in this manual. A TRS (Tip-Ring-Sleeve, 3- conductor) Stereo cable is necessary to connect most multi-effect units to an external control box or foot pedal.</p>
<p>DRY/WET Fader</p>	<p>This fader controls the ratio of “dry” (without effects) and “wet” (with effects) signals sent to the Master Level control. Counterclockwise is dry, clockwise is wet.</p> <p>DRY/WET FADER – EFX SEND + LEVEL (rear panel) - EFX RETURN + LEVEL (rear panel) – The Dry/Wet Fader and rear panel effects loop is a very powerful feature that allows effects to be added to the analog signal chain in a number of ways.</p> <p>The level sent out to the effects unit can be adjusted using the EFX Send Level on the rear panel. This is adjustable to drive effect inputs from, -30dB to +4dB; the +4dB setting generates the highest output. It’s very important to ensure the TCA-500C Overload LED just starts to blink BEFORE the effects processor input level reaches its maximum input level or clipping point. The average user can easily ensure the correct and proper EFX send level by looking up the preferred level in the manual for the appropriate multi-effects units and setting the EFX RETURN and EFX SEND controls on the TCA-500C to specified levels.</p> <p>Normally these levels will be -10 dBu, -8 dBu, -4 dBu, 0 dBu or +4 dBu. The TCA-500C provides the ability to match virtually any high quality EFX units.</p> <p>The level returned from the effects unit can be reduced or boosted using the EFX Return Level on the rear panel. This is adjustable over the range from, -30dB to +4dB; the +4dB setting applies the highest gain to the returned signal. This level should be adjusted so the effects processor output doesn’t cut or boost the signal; we call this ‘unity’ gain. A good way to check this is to set the effects processor to ‘bypass’: Then set the DRY/WET Fader fully Wet and then fully Dry, you should notice virtually no change in volume; adjust the EFX Return Level to achieve this.</p>

**TCA-500C COMBO AMP CONTROL FUNCTIONS, JACKS, & INDICATORS:
FRONT PANEL (CONTINUED)**

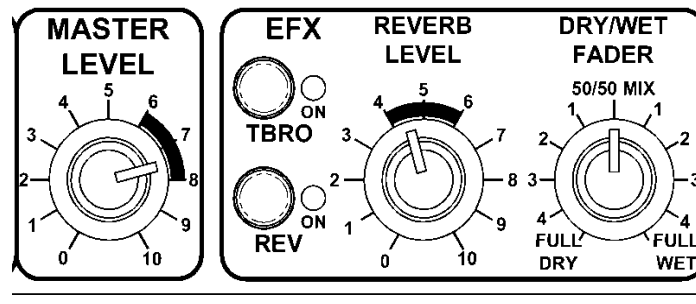

<p>DRY/WET Fader (continued)</p>	<p>Your effects send and return levels should now be optimised. We suggest you note the settings.</p> <p><u>Series Effects Loop Mode</u></p> <p>By setting the Dry/Wet Fader fully Wet, mono effects can be introduced in a series chain i.e. the entire signal passes through the effects loop and no thru signal is added to the effected signal. This mode is useful where compression or modulation effects need to be added.</p> <p>Most effects processor manufacturers recommend series mode, there is however a down side when using effects processors as part of series chain. To generate high quality effects requires complex mathematics and powerful processors, and time to perform the calculations. This introduces a small delay as the signal passes through the effects processor; this delay is called 'latency'. A high performance processor like the T.C. Electronics G-Major/2 introduces a delay of about 1.6 milliseconds into the signal chain.</p> <p>If you consider reverb or delay effects this latency has negligible effect, as the effect you are using is in fact delay based itself. But in a series chain effect arrangement the straight through signal will also be delayed by 1.6 milliseconds. There is considerable debate whether or not this delay can be detected by the player. In tests we've carried out, comparing series and parallel effects patches, it is our opinion that it is, in fact, detectable by some players.</p> <p>For this reason we would therefore not recommend using effects processors in a series mode that introduce latency.</p>
---	--

**TCA-500C COMBO AMP CONTROL FUNCTIONS, JACKS, & INDICATORS:
FRONT PANEL (CONTINUED)**

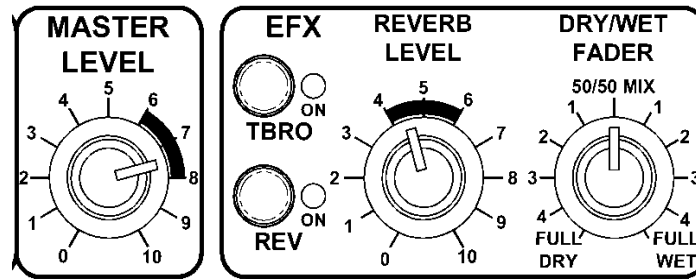

**DRY/WET Fader
(continued)**

Parallel Effects Loop Mode

By setting the Dry/Wet Fader at a mid-way point, the dry or thru signal will be mixed with the effected signal. Typically a 12 o'clock position is a good starting point.

The EFX Return Level should be adjusted so the effects processor adds a typical effect level when the Dry/Wet Fader is in the 12 o'clock position. Note the effects processor patch settings will also affect this level; good noise / headroom practice must be considered when developing patches.

In parallel mode the dry or thru signal is passed within the TCA-500C and only the effected signal is returned by the effects processor. When developing patches for parallel mode use, it is essential that the effects processor is not allowed to pass an unaffected or straight through signal. If this occurs, the true thru signal will mix with the latency delayed thru signal and generate a modulated dry signal. This might in some situations sound nice while setting up the patch, but in a live performance or recording situation this often corrupts the general EQ, messing up the natural sound of the instrument.

A well configured parallel effects loop, with a suitably configured delay and reverb effect only being returned, enhances the natural sound of the steel guitar and most other instruments. The T C Electronics G-Major/2 effects processor has some suitable routings with good control of both the effect mix and effect level, for both delay and reverb. A number of patches have been developed for this unit to be used with the TCA-500C.

The ability to adjust the Dry/Wet Fader to control the effects level in a live performance situation is another advantageous feature of parallel mode.

TCA-500C COMBO AMP CONTROL FUNCTIONS, JACKS, & INDICATORS: FRONT PANEL (CONTINUED)

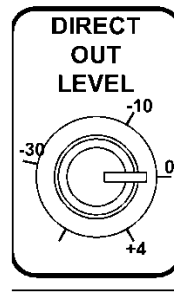
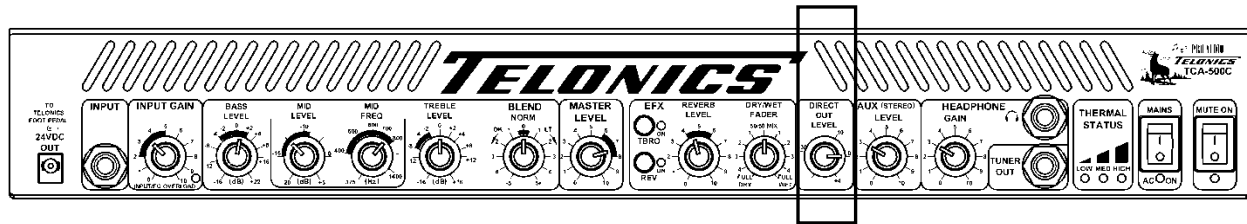

<p>Direct Out Level – Gnd Lift</p>	<p>This level adjustment will allow you to match the D.O. signal you are sending, to the proper level required by the mixer board or recording device. Most line level devices are either +4dB or -10dB. You can adjust for either, however, you can also adjust your Direct Output signal low enough for microphone inputs with below -30dB adjustment- this is an unusual capability. This allows you to use your high quality balanced XLR Direct Output with low end mixer boards which only provide mic level inputs. (A very handy capability when you walk into a new venue cold and have no idea what the sound person might have to work with.)</p> <p>The D.O. in the TCA-500C is analog modeled to deliver to a flat response system, a very closely EQ'd approximation to what is output from the combo speaker in its cabinet.</p> <p>The signal sent from the XLR connection is balanced line and male gendered (standard XLR out). The GND Lift push button (rear panel) allows the combo earth to be separated from the DI earth to assist with hum ground loop issues. The front panel Direct Level control allows the signal sent to the desk/house board to be easily adjusted over a wide range.</p> <p>Note: when the Power Amp On/Off switch (rear panel) is Off (i.e. no sound is output from the combo speaker, but the headphones output is still active), the D.O. output remains ON because the preamplifier section is ON.</p>
---	--

TCA-500C COMBO AMP CONTROL FUNCTIONS, JACKS, & INDICATORS: FRONT PANEL (CONTINUED)

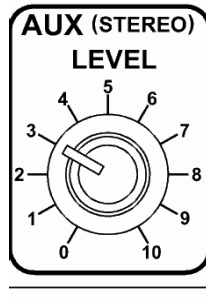
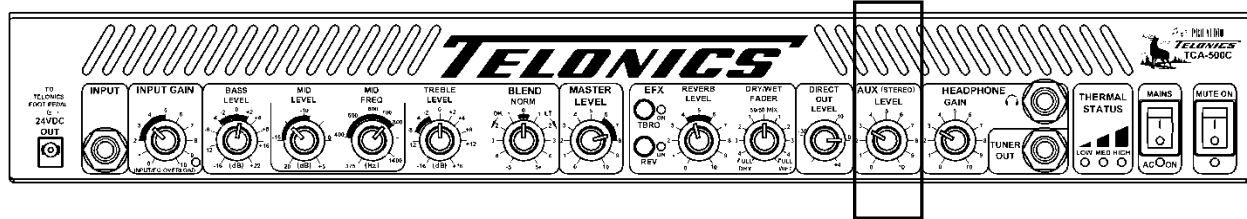

<p>Aux Level (Stereo)</p>	<p>The Auxiliary level control is used to set the level of background/track music from MP3 players, CD players or other audio sources.</p> <p>This input accepts a standard ¼ inch TS or TRS plug. Most MP3 players require a 1/8 inch TRS plug. Accordingly, a 1/8 inch-to-1/4 inch TRS cable is supplied with the TCA-500C. Some CD players still utilize separate RCA jacks and therefore require a dual RCA plug (male) to ¼ inch TRS plug cable. These are readily available at most home entertainment electronics stores and are generally stocked at Telonics as well.</p> <p>As such, the Auxiliary Input is not designed for low-level instrument signals. HOWEVER, it may also be used as a second channel input from an external source such as a preamp and/or effects chain. For example, a musician who doubles on a second instrument might connect the output of a preamp, compressor and/or other EFX units following his instrument to the Aux input on the rear panel of the TCA-500C, thus providing for quick switching to a Tele, MandoCaster, mandolin, or other instrument.</p> <p>Note: the Aux Input ties in after the EQ and Dry/Wet controls. You can only control the level of this signal.</p>
----------------------------------	---

**TCA-500C COMBO AMP CONTROL FUNCTIONS, JACKS, & INDICATORS:
FRONT PANEL (CONTINUED)**

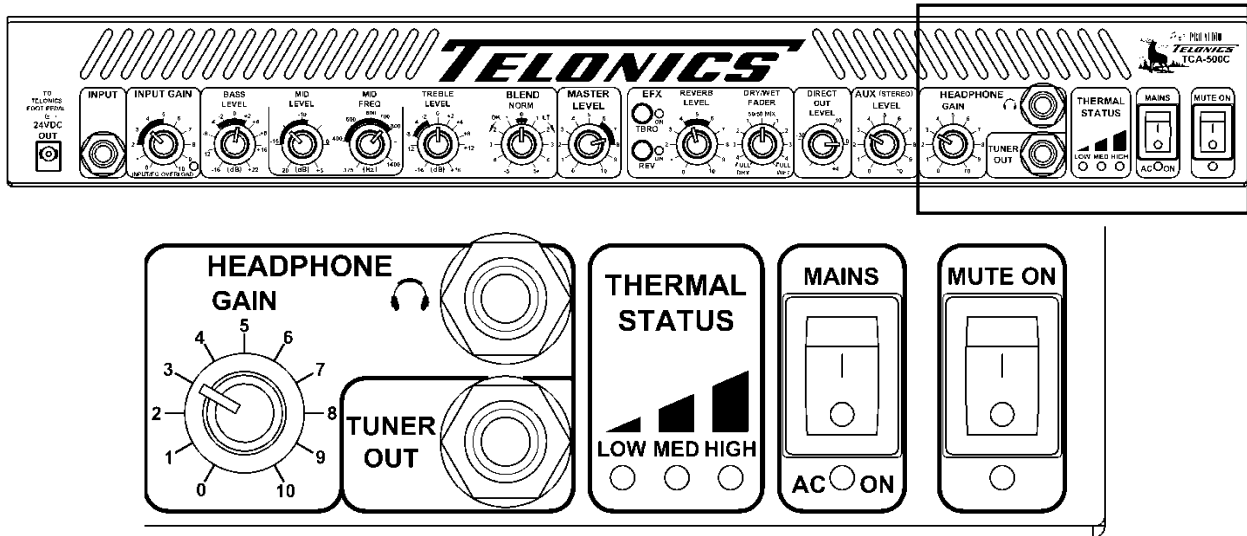

Headphone Gain	Adjusts headphone output level. <u>Turn down when not in use.</u>
Headphone Jack	<p>The headphones output is a high level stereo ¼” TRS Jack output, capable of driving headphones impedances of 8 Ohm or higher.</p> <p>WARNING – High headphone levels may damage your hearing</p> <p>The Headphones Gain control allows the headphone output level to be adjusted.</p> <p>The Mute ON and Power Amp switches do not affect the headphones output.</p> <p>This unit puts out up to half a watt per channel into 8 ohm – more than enough for any player at home. We recommend using quality headphones such as Sony model MDR 7505.</p>
Tuner Out	<p>This is a buffered output so it will not load down the pickup or the rest of the signal chain, nor will it allow noise from the tuner to get back into the system. Output impedance is approximately 500 ohm. This output is buffered for feeding to a guitar tuner.</p> <p>The Mute ON switch does not affect this output; it is always ON.</p>
Thermal Management and Power Amplifier Off Status	<p>The Thermal Management Status indicates the temperature status of the power amplifier. The LEDs indicate a low (green), medium (yellow), or high (red) temperature range. (For more details see the Thermal Management System section)</p> <p>These Three LED’s are also used to remind the user that the Power Amplifier switch on the rear panel is in the OFF position when blinking in groups of three (3) blinks, therefore no sound will be heard from the speaker.</p> <p>The LEDs will also indicate a fan speed out of specification condition as described later, in the Thermal Management System; Fan Speed out of Spec Indication paragraph.</p>

**TCA-500C COMBO AMP CONTROL FUNCTIONS, JACKS, & INDICATORS:
FRONT PANEL (CONTINUED)**

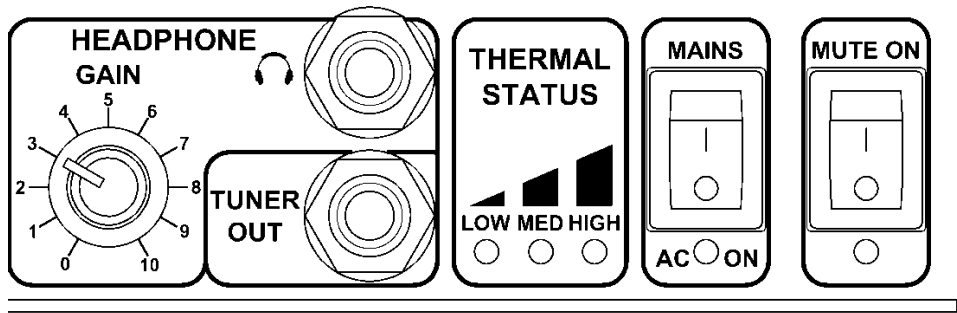

Green LED	The green LED will blink; On for a short time then Off, once a second while the temperature is below the Low setting. This “wink” (short blink, once per second) lets you know that the Thermal Management System is working. As the temperature increases the green LED will come On solid while the temperature is at or above the low setting.
Yellow LED	The yellow LED will come On solid if the temperature is at or above the medium set point.
Red LED	The red LED will come On solid if the temperature is at or above the high set point.
When the Power Amplifier switch on the rear panel is switched to OFF these LED’s will alternate, blinking in groups of three (3) blinks, first showing the appropriate LED(s) to indicate temperature, then all three LEDs will blink 3 times, then the LED(s) showing temperature will blink 3 times , then all three, and so on. Note: If the temperature is High, then all three (3) LEDs will blink each time.	
MAINS Switch / Blue AC On LED	Mains Power ON / OFF switch / AC ON LED (blue) – The AC power switch is located on the front panel. The blue AC On LED on the front panel indicates AC mains power is applied and the AC Mains Power switch is On . After the switch is turned on, there will be a delay of about five seconds before the blue LED lights, indicating the amplifier is ready for use. This delay is intentionally provided to mute boot-up noise from external effects units.
Mute	MUTE ON switch / LED (yellow) – The Mute ON switch mutes the output to the Power Amplifier, to the XLR Direct Out and to the PRE OUT; it <u>does not</u> affect the Headphone output, Effects Send and Pedal TO outputs. The Mute circuitry is designed to be super quiet when switched On and Off. When the Mute is On the Yellow Mute LED is lit. The Mute system in the TCA-500C is very handy for string replacement, practice licks, tuning, and effects adjustment during live venue situations.

TCA-500C COMBO AMP CONTROL FUNCTIONS & JACKS: REAR PANEL

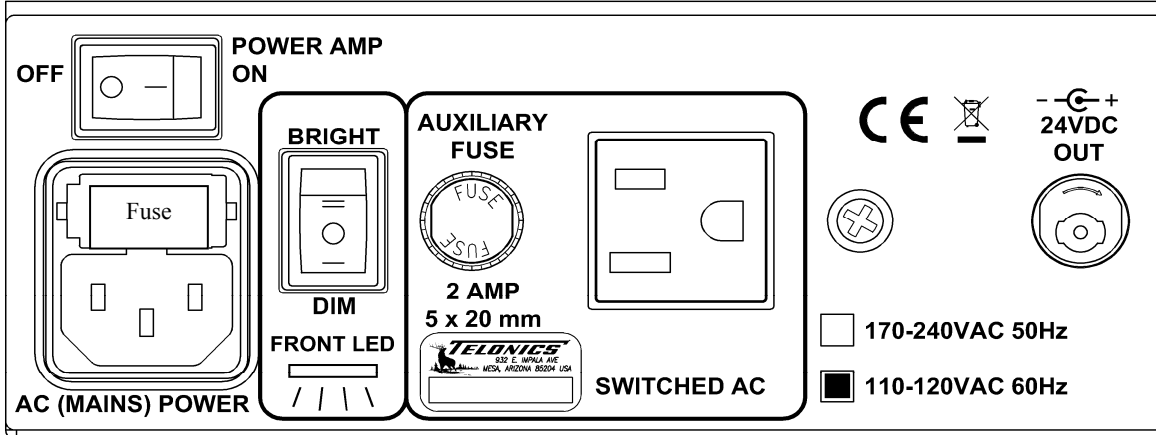
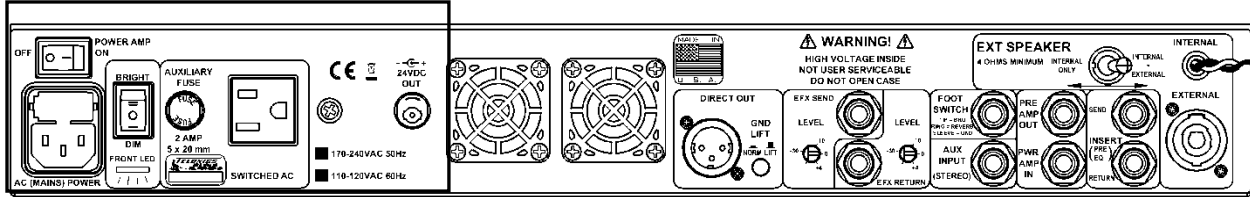

<p>Power Amp ON/OFF</p>	<p>Turns the power amplifier On and Off. A time delay is built into the audio circuits to minimize “pop” when turning On or Off. Note: The preamp is still operational when the PA is off.</p> <p>The Power Amp ON switches the Power Amp On/Off. It does not affect the XLR Direct Out or the Headphones. When the Power Amp ON switch is Off the cooling fans are disabled, after a few seconds, to minimize noise for use in a studio.</p> <p>This is an important professional feature for studio and live venue work using the Direct Out from the Combo Amp. To use it, first establish your working stage/studio volume through the combo speaker. Then turn the Power Amp OFF and adjust your output level using the Direct Out level control on the front panel to suit your taste (This will allow you to hear the house/studio system without the local sound of your amp). <u>Don’t forget to turn the Power Amp back ON after this adjustment</u>, as your cooling has been disabled while the PA is OFF.</p> <p>Hint: If you ever find yourself at a live gig, trying to get sound from your combo, but nothing is coming out, check this switch – someone may have turned your power amplifier off! Your Temperature LEDs will be blinking in groups of 3 blinks to warn you.</p>
<p>AC (MAINS) Power Input</p>	<p>110-120VAC input*. Standard C13 plug on an 18 AWG cord is recommended. The power input is fused with an 8 amp 250VAC 5x20mm ceramic Slow Blow fuse.</p>

*NOTE: Standard versions are wired for domestic use only. Export units are available on special order. Export AC Power Input range is 170-240 VAC, 50-60 Hz with an 8A 250VAC fuse.
CAUTION: Voltages outside this range could damage the unit and cause a shock hazard.

**TCA-500C COMBO AMP CONTROL FUNCTIONS & JACKS:
REAR PANEL (CONTINUED)**

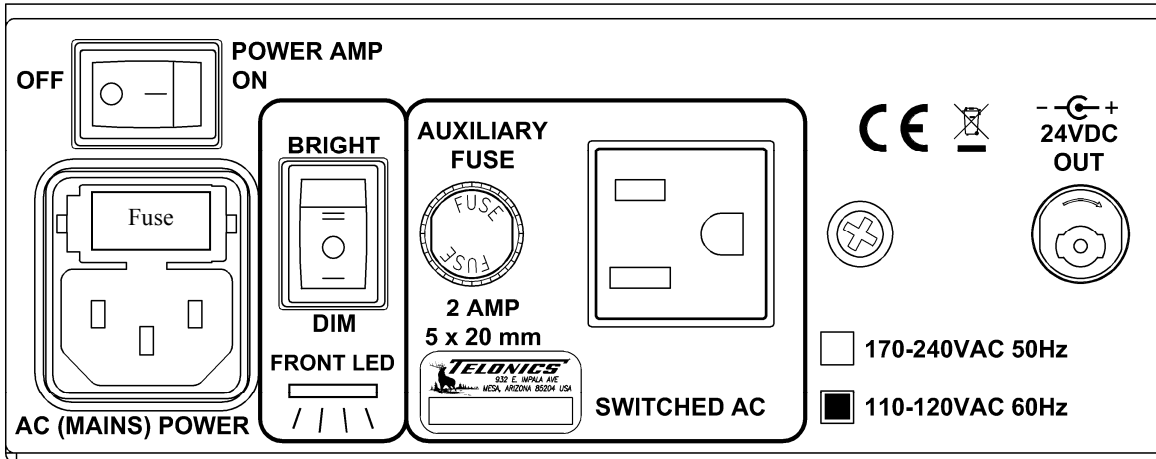

<p>AC (MAINS) Power Input (cont.)</p>	<p>WARNING - Before checking this fuse ALWAYS ensure the combo is disconnected from the mains supply.</p> <p>Main Fuse (rear) – The AC mains protection fuse is located on the rear panel. It is in a fuse drawer directly above the AC mains power cord socket. Use a small screwdriver to release the spring latch on each side of the drawer to release the fuse drawer.</p> <p>If tests / a visual inspection of this fuse indicate it is open circuit, <u>take caution</u>, your combo may have developed a fault.</p> <p>ONLY replace the fuse with the EXACT type – <u>Ceramic 8 Amp: 5 x 20mm: 250 Volt.</u></p> <p>Note: If the fuse should blow immediately after being replaced DO NOT try it again, this could cause more damage; return the combo to Telonics for testing and repair.</p>
<p>Front LED Light</p>	<p>The Front LED Light switch is a three-position toggle switch which turns the Front panel LED illumination system to one of the following conditions: “Bright” “Off” or “Dim”.</p>

**TCA-500C COMBO AMP CONTROL FUNCTIONS & JACKS:
REAR PANEL (CONTINUED)**

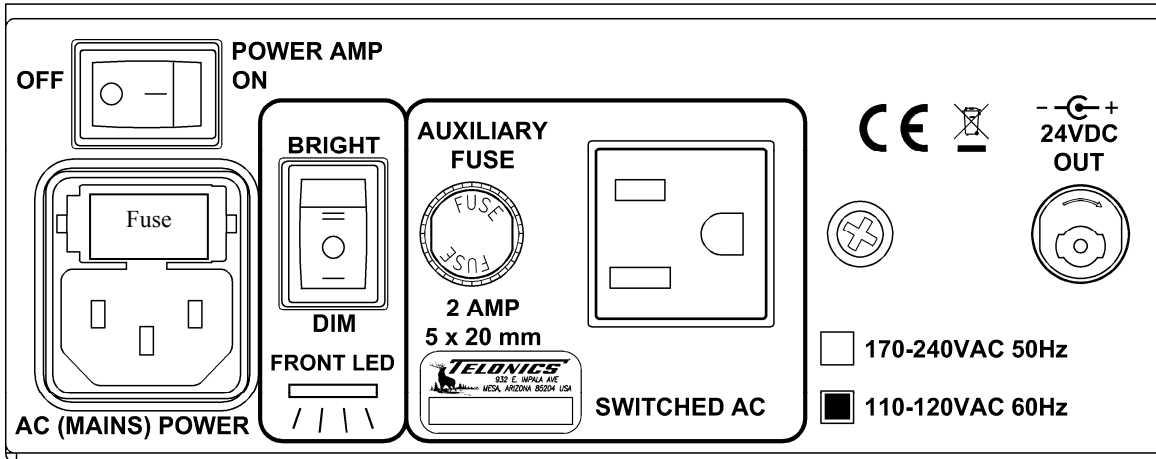

<p>Switched AC Outlet Socket and Auxiliary Fuse (rear panel)</p>	<p>WARNING - Before checking this fuse ALWAYS ensure the combo is disconnected from the mains supply.</p> <p>Switched 110-120VAC outlet, fused with a 2 amp 250VAC 5x20mm glass Slow Blow fuse. Note: This outlet is a C14 connector in the export version.</p> <p>To allow the combo to be powered from a single AC cord, a switched AC power socket is provided to power up an external effects unit.</p> <p>WARNING – Mains voltage is present on this connection – DO NOT plug in any device into this socket other than those that accept the AC mains voltage. If any liquid is spilled on the combo in this area UNDER NO CIRCUMSTANCES should the combo be used, and the AC mains cord plug should be IMMEDIATELY disconnected from the AC mains supply socket.</p> <p>The output voltage from the Switched AC socket will be the same as applied to the combo AC mains cord plug. Always check to be certain that your effects processor voltage suits the supply voltage applied to the TCA-500C Combo Amplifier.</p> <p>Note: the power taken by the effects processor should not exceed 50 Watts.</p>
<p>24 VDC OUT (Combo Model) (Head Unit Model)</p>	<p>This jack is in parallel with the 24VDC Out on the front panel. The power supply is isolated from the main amplifier and can supply 0.2 amps maximum. Note: Center pin is Positive (+).</p>
<p>9 VDC OUT (Mini-Combo Models Only)</p>	<p>This jack is available to provide 9 volts (regulated) DC power (1.0 amps maximum) for external effects units which the user might wish to use with the Mini-Combo Models.</p> <p>Note: center pin is Negative (-) to comply with “stomp box convention” standards.</p>

**TCA-500C COMBO AMP CONTROL FUNCTIONS & JACKS:
REAR PANEL (CONTINUED)**

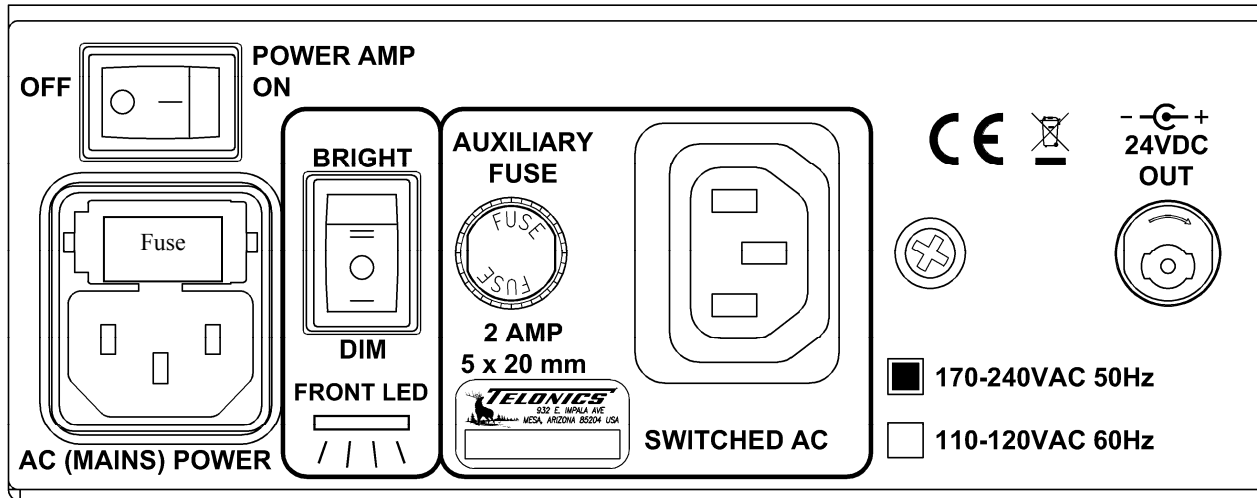

<p>Switched AC Outlet Socket Export version (rear panel)</p>	<p>Switched 170-240VAC outlet, fused with a 2 amp 250VAC 5x20mm glass Slow Blow fuse. Note: This outlet is a C14 connector in the export version shown above.</p> <p>To allow the combo to be powered from a single AC cord, a switched AC power socket is provided to power up an external effects unit.</p> <p>WARNING – Mains voltage is present on this connection – DO NOT plug in any device into this socket other than those that accept the AC mains voltage. If any liquid is spilled on the combo in this area UNDER NO CIRCUMSTANCES should the combo be used, and the AC mains cord plug should be IMMEDIATELY disconnected from the AC mains supply socket.</p> <p>The output voltage from the Switched AC socket will be the same as applied to the combo AC mains cord plug. Always check to be certain that your effects processor voltage suits the supply voltage applied to the TCA-500C Combo Amplifier. Note: the power taken by the effects processor should not exceed 50 Watts.</p>
<p>24 VDC OUT (Combo Model) (Head Unit Model)</p>	<p>This jack is in parallel with the 24VDC Out on the front panel. The power supply is isolated from the main amplifier and can supply 0.2 amps maximum between both connectors. Note: Center pin is Positive (+).</p>
<p>9 VDC OUT (Mini-Combo Models Only)</p>	<p>This jack is available to provide 9 volts (regulated) DC power (1.0 amp maximum) for external effects units which the user might wish to use with the Mini-Combo Models. Note: center pin is Negative (-) to comply with “stomp box convention” standards.</p>

TCA-500C COMBO AMP CONTROL FUNCTIONS & JACKS: REAR PANEL (CONTINUED)

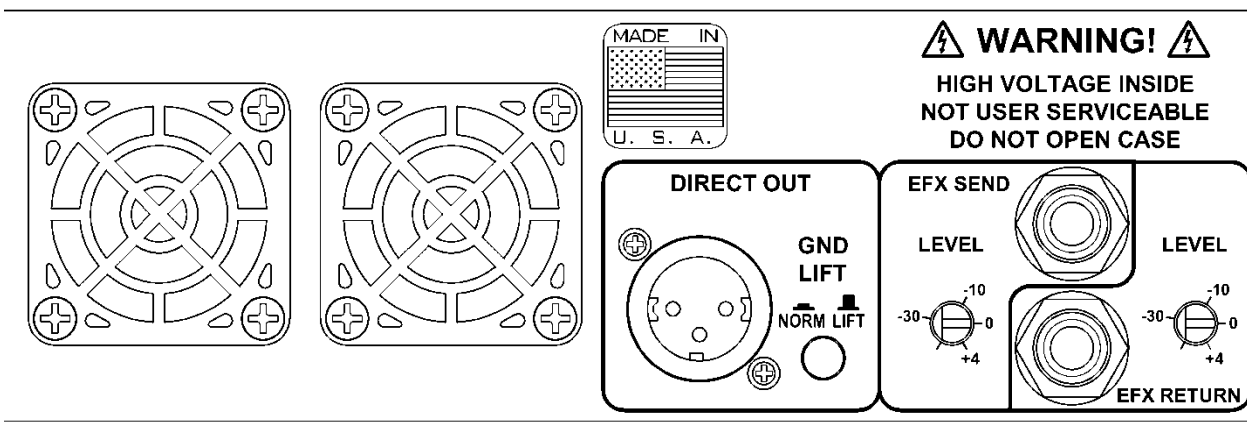
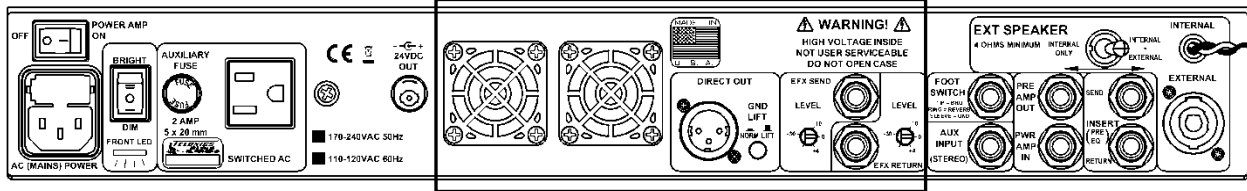

<p>Direct Out XLR</p>	<p>Buffered post effects, post EQ signal for studio or stage use. Output impedance = 600 ohm. The XLR connector is wired to the standards for audio. Pin 1 is shield, Pin 2 is signal plus, and Pin 3 is signal minus. The Direct Out Level control is on the front panel. The range of the control is approximately -60dB to +4dB.</p>
<p>Direct Out GND Lift</p>	<p>This switch allows you to disconnect Pin 1 of the XLR connector from the chassis ground. It is seldom necessary in properly built equipment, but might be needed sometime. Leave in the Norm (In) position unless needed.</p>
<p>EFX Send Level</p>	<p>This adjusts the level to your effects unit. This will allow you to have enough of a signal to make the effects work well and yet not overdrive it.</p>
<p>EFX Send Jack</p>	<p>Mono send to parallel mode effects unit input. Use a ¼ inch TS (tip, sleeve) mono phone plug.</p>
<p>EFX Return</p>	<p>This is a mono (TS) input from your effects unit mono output.</p>
<p>EFX Return Level</p>	<p>This potentiometer allows you to select the nominal signal level coming from your effects unit, it is adjustable from +4dB to less than -30dB. Most “Pro” equipment is usually +4dB while consumer equipment is usually -10dB.</p>

TCA-500C COMBO AMP CONTROL FUNCTIONS & JACKS: REAR PANEL (CONTINUED)

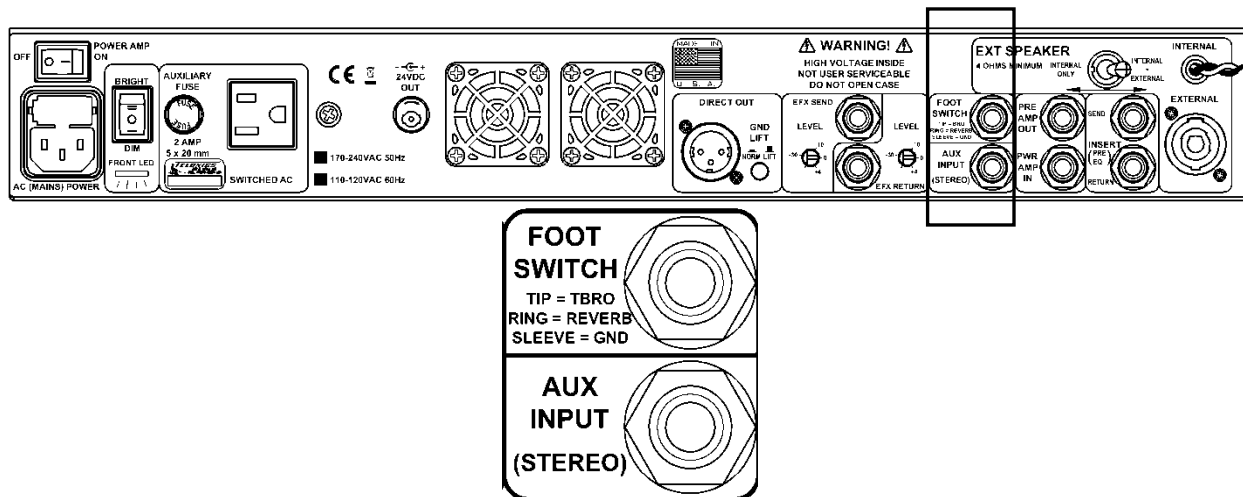

Foot Switch	<p>The Foot Switch jack on the rear panel may be used to switch the TBro and/or the internal Reverb effects circuit on and off. A ¼ inch TRS (tip, ring, and sleeve) stereo plug is needed. The sleeve is common, tip is TBro and ring is reverb. The switch will enable the effects in the closed position.</p> <p>Note that the type of switch to be used must ‘not’ be a momentary contact type, but rather a continuously on or off type, such as a toggle switch.</p>
Aux Input (Stereo)	<p>The Auxiliary Input on the rear panel accepts a ¼” stereo or monaural plug and may be used to inject audio from a CD, MP3 player or other line level source, for home practice or live gigs. Use the Aux (stereo) Level control on the front panel to set the desired music level.</p> <p>The Aux Input provides a secondary input to the amplifier that sums into the system such that it can be heard via the headphones, main speaker and XLR Direct Out. The Aux Input is a stereo ¼” TRS Jack input; signals fed via this input in stereo will remain in stereo when fed out to the stereo Headphones jack. Signals fed via this input are summed to a mono signal before being fed to the speaker and XLR Direct Out.</p> <p>This input can be used in one of three ways:</p> <ol style="list-style-type: none"> i) A CD / MP3 Player connected to the Aux Input will allow tracks to be played for practice and small gigs. ii) An additional effects processor output can be returned via this input. iii) A guitar effects unit output can be connected into this input, enabling the amplifier to be used for both steel and guitar. <p>Note; this input is optimised for a 0dB line level signal.</p> <p>Note; Signals applied to the Aux Input will be analog modelled when output from the Direct Out.</p>

TCA-500C COMBO AMP CONTROL FUNCTIONS & JACKS: REAR PANEL (CONTINUED)

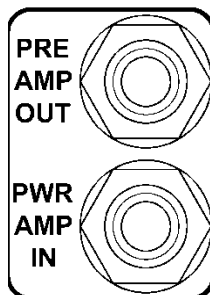
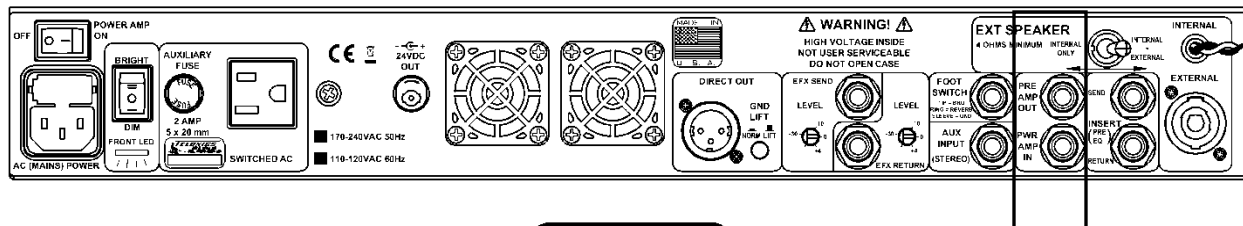

<p>Preamp Out</p>	<p>The Preamp Out jack is a line level output from the preamplifier section of the TCA-500C that can be used to send the fully processed signal to another power amplifier, powered speaker, etc.</p> <p>Using a standard guitar cable with 1/4 inch TS mono plugs on both ends, this jack can be used to treat this TCA-500C as a “Master” unit, which can control a second TCA-500C as a “Slave – thus providing a total of 1000 watts of total amplifier power (500 per unit).</p> <p>(Note that when this is done, a ground lifting device such as a HUM-X must be used on the “Slave” unit in order to prevent a loud and unpleasant ground loop hum.)</p>
<p>Power Amp Input</p>	<p>The Power Amplifier Input accepts line level signals from another source to the power amplifier and local speaker in the TCA-500C Combo Amplifier. When used, this jack will disconnect the internal preamplifier signal from going to the Power Amp. Only the external signal coming in on the TS mono plug will be amplified through the speaker.</p> <p>PRE OUT / PA IN (jacks, rear) – These jacks allow two TCA-500C combo’s to be slaved together. Connect a lead from the Pre Out of the Master combo (<i>The combo that the guitar is plugged into</i>) to the PA In of the Slave combo. The output from the speaker of the master and slave combo’s will now be the same. When adjustments are made to the master combo controls both combos’ outputs will be affected.</p> <p>(Note that when this is done, a ground lifting device such as a HUM-X must be used on the “Slave” unit in order to prevent a loud and unpleasant ground loop hum.)</p>

TCA-500C COMBO AMP CONTROL FUNCTIONS & JACKS: REAR PANEL (CONTINUED)

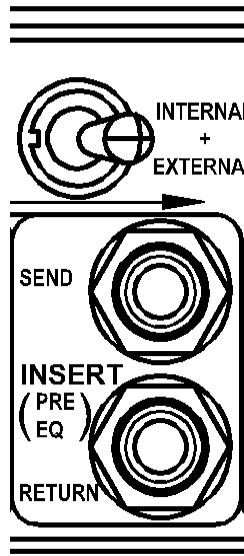
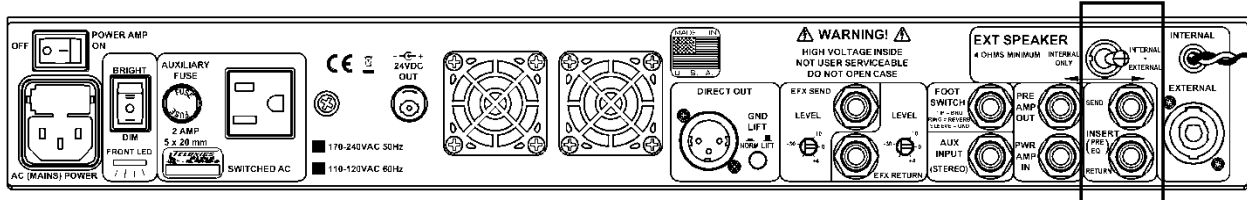

<p>Pre EQ Insert Send</p>	<p>This insert send follows the Input 1 Gain control on the front panel. It may be used as a pedal loop or a series effects loop.</p>
<p>Pre EQ Insert Return</p>	<p>This insert return is prior to all of the effects and equalization circuits. This includes TBro, Hum, Reverb, Wet/Dry fader, and all of the Input Tone controls.</p>

TCA-500C COMBO AMP CONTROL FUNCTIONS & JACKS: REAR PANEL (CONTINUED)

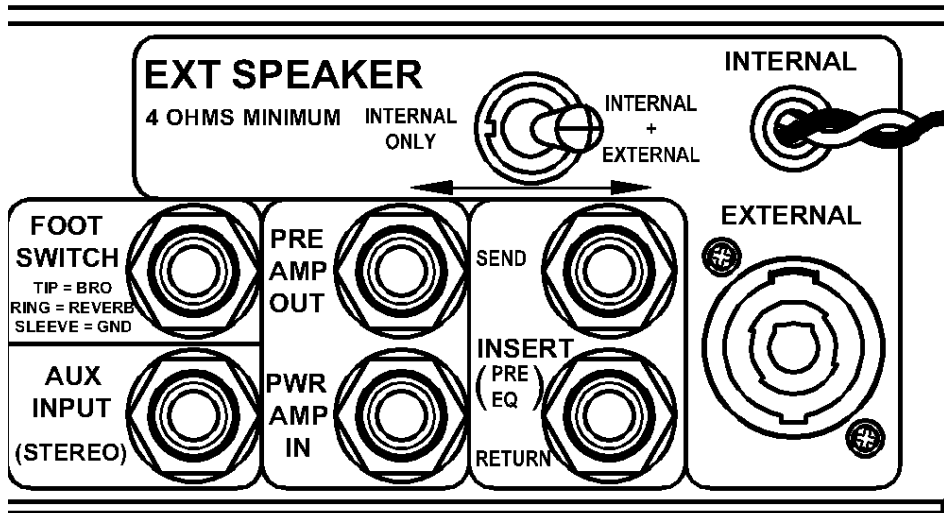
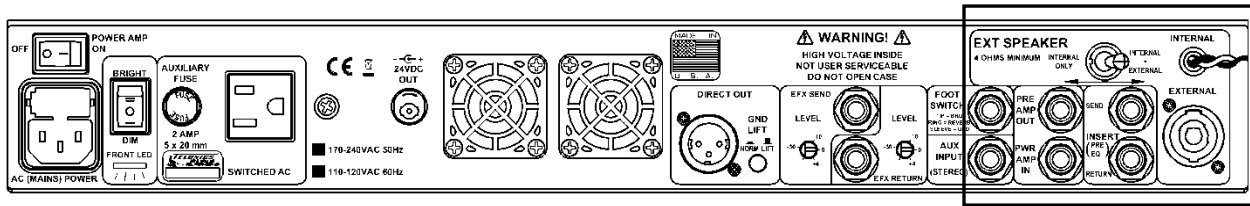

Ext Speaker	With the switch in the Internal Only position, the Internal (Black & Red wires) speaker is all that is used. In the Internal + External position, the external speaker is placed in series with the internal 4 ohm speaker.
Internal (Red and Black)	This is the bridged output to the speaker. This output is active in both switch positions. The internal speaker impedance must be greater than 3 ohm. The red wire is (+) or positive phase, the black wire is (-) or negative phase. CAUTION: Both wires have an audio AC voltage on them. DO NOT allow them to short to ground when the amplifier is on, as this could cause a failure. NEVER use grounded equipment to measure the speaker output.
External	This jack (combination Speakon or ¼ inch TS) is used to connect to the external speaker. The ¼ in TS plugs into the center hole of the Speakon jack. The external speaker is only active when the switch is in the Internal + External position.
NOTE:	We recommend using a 4 ohm external speaker. (You can use an 8 ohm or even a 16 ohm external speaker; however the volume level from the external speaker will be slightly lower than the internal speaker.)

**TCA-500C COMBO (ONLY) AMP CONTROL FUNCTIONS & JACKS:
REAR PANEL (CONTINUED)**

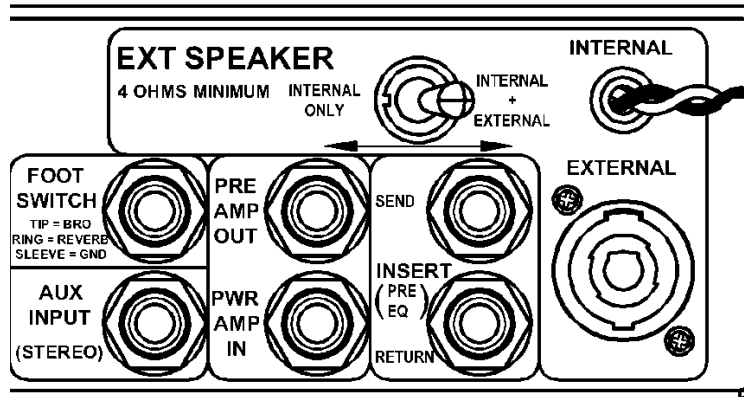
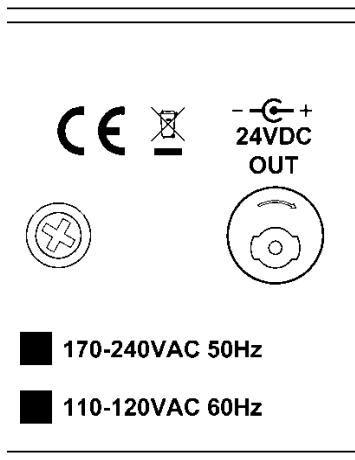
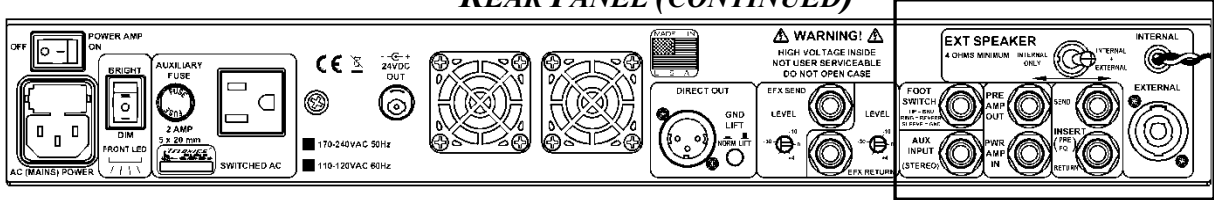

The Combo Amp unit has the 24 volt DC output and the Ext Speaker option.

<p>24VDC OUT Connector</p>	<p>The isolated 24 volt output uses the same connector as the 9 volt option, but the center pin is (+) positive and the outer ring is (-) negative. The 24 volt output is more common for external EFX units, such as The Handy Patch remote MIDI Controller. The 24 volt supply on the rear panel is in parallel with the front connector and the common supply can supply up to a total of 0.2 amps of current maximum for both connections.</p>
<p>Ext Speaker</p>	<p>With the switch in the Internal Only position, the Internal (Black & Red wires) speaker is all that is used. In the Internal + External position, the external speaker is placed in series with the internal 4 ohm speaker. (See more details on the previous page.)</p>

TCA-500C 15" MINI-COMBO (INTERNAL SPEAKER) AMP CONTROL FUNCTIONS & JACKS: REAR PANEL

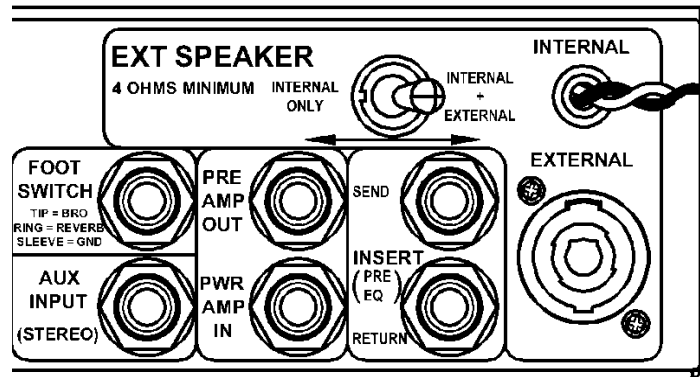
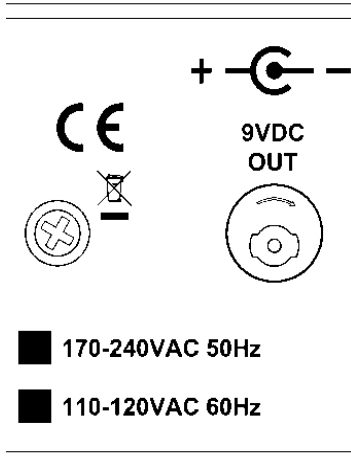
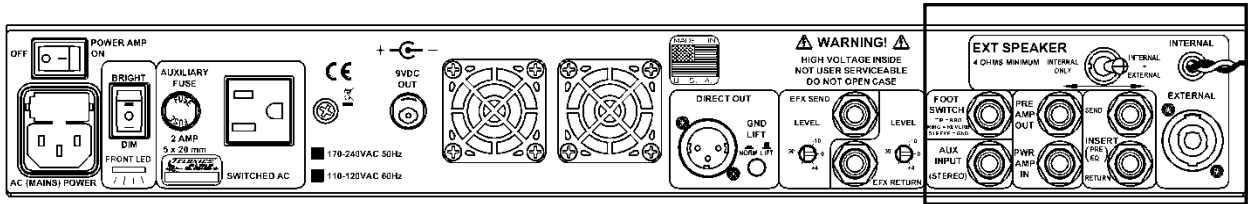

The Mini-Combo Amp unit has the 9 volt DC output and External Speaker option.

-9VDC OUT Connector Option	The isolated 9 volt output uses the same connector as the 24 volt option, but the center pin is (-) negative and the outer ring is (+) positive. The 9 volt output is more common for “stomp” box effects units, which a lot of Mini-Combo users are used to. The 9 volt supply can supply up to 1 amp (1000mA) of current.
Ext Speaker	With the switch in the Internal Only position, the Internal (Black & Red wires) speaker is all that is used. In the Internal + External position, the external speaker is placed in series with the internal 4 ohm speaker. (See more details on page 29.)

TCA-500C 12" MINI-COMBOS (WITH EXTERNAL SPEAKER) AMP CONTROL FUNCTIONS & JACKS: REAR PANEL

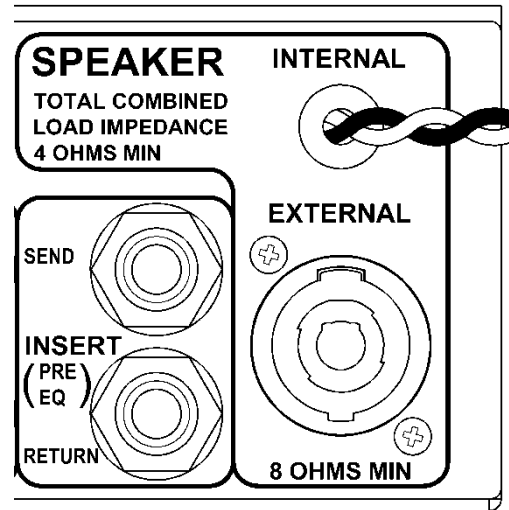
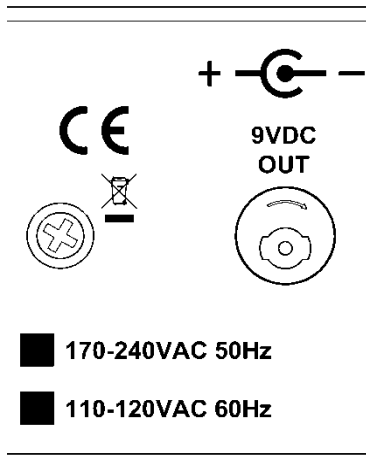
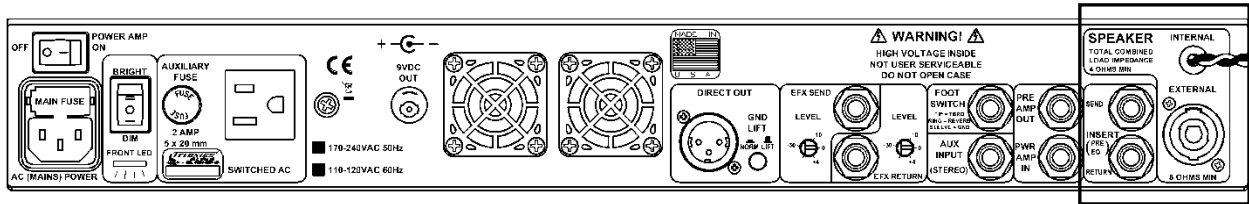

The 12 inch 8 ohm TCA-500B Mini-Combos have a 9 volt DC output and built in speaker wire with an additional Speakon connector for connection to a parallel external 8 ohm speaker.

<p>-9VDC OUT Connector Option</p>	<p>The isolated 9 volt output uses the same connector as the 24 volt option, but the center pin is (-) negative and the outer ring is (+) positive. The 9 volt output is more common for “stomp” box effects units, which a lot of Mini-Combo users are used to. The 9 volt supply can supply up to 1 amp (1000mA) of current.</p>
<p>External Speaker Output Option (Standard Mini-Combo amps are supplied with 4 ohm Telonics NEO Speakers)</p>	<p>The Mini-Combos can, as an option, have an internal 8 ohm 12 inch speaker connected using the Red and Black wires. With the 8 ohm speaker option, this allows for an external 8 ohm speaker to be used in parallel. The Speakon connector allows you to use a ¼” jack in the center or use a regular Speakon connector to connect the external 8 ohm speaker. As indicated on the rear panel the minimum total speaker load impedance must be greater than or equal to 4 ohms. Two 8 ohm speakers in parallel equal 4 ohms. An 8 ohm and a 4 ohm speaker in parallel equal 2.67 ohms which is too low an impedance load.</p>

TCA-500C HEAD UNIT (ONLY) AMP CONTROLS FUNCTIONS & JACKS: REAR PANEL

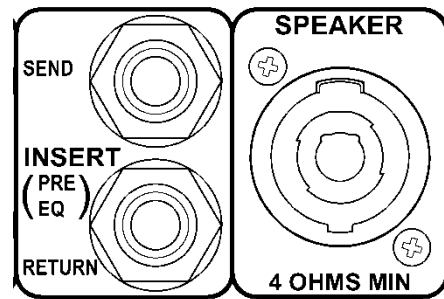
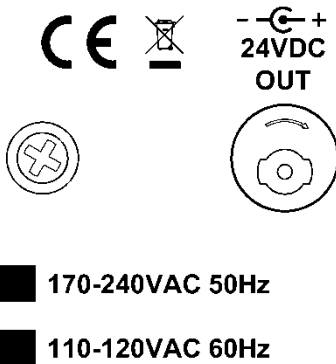
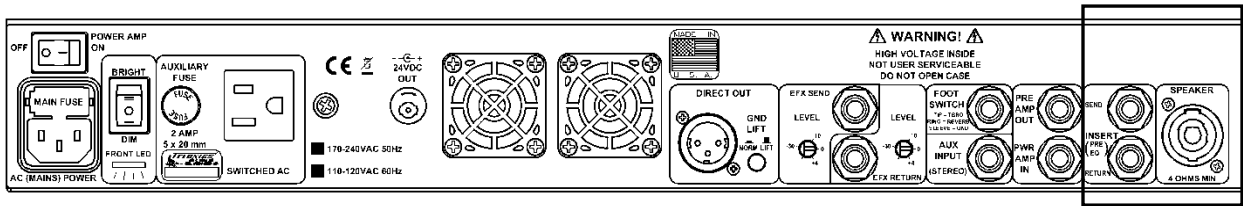

The Head unit has the 24 volt DC output and a Speakon Connector only.

<p>24VDC OUT Connector</p>	<p>The isolated 24 volt output uses the same connector as the 9 volt option, but the center pin is (+) positive and the outer ring is (-) negative. The 24 volt output is more common for external EFX units, such as The Handy Patch remote MIDI Controller. The 24 volt supply on the rear panel is in parallel with the front connector and the common supply can supply up to a total of 0.2 amps of current maximum for both connections.</p>
<p>Speaker Output</p>	<p>The Head Amp Speaker Output only has a combo Speakon connector for the speaker connection. A 1/4" plug can be used in the center connection of the jack or a standard Speakon plug to connect to your speaker. The minimum impedance is 4 ohms.</p>

TCA-500C COMBO AMP SETUP SETTINGS: GENERAL USE SETTINGS

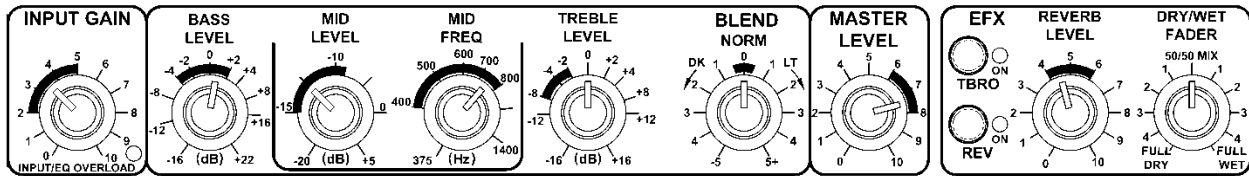

The EQ settings shown above are suitable as a starting point for users who desire a more general setting for all styles with middle-to- slightly darker tonal coloration.

As stated earlier, the MID frequencies are the key. Turning the MID Frequency control slightly clockwise will reduce highs further. You may also want to pull the Middle frequencies down a bit further toward -14 or -15 dB if the Mids are still too “in your face” with your pickup.

Once the equalization is set to your satisfaction, the BLEND control can be rocked slowly while striking a wide grip of strings repeatedly to accurately “fine tune” all the EQ settings at one time.

Remember that these controls are sensitive, so a little adjustment can change a lot.

MAXIMUM CLARITY SETTINGS

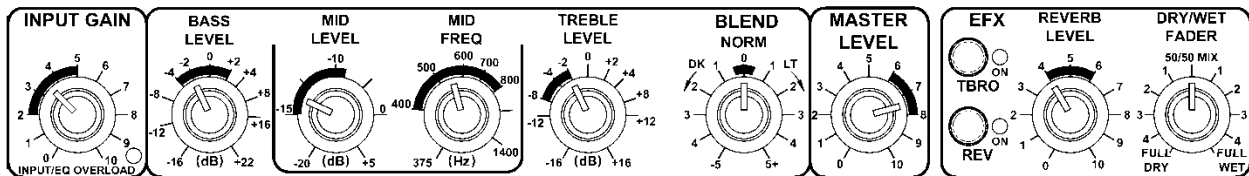

The EQ settings shown above are suitable as a starting point for users who desire a very crisp and sharp, setting with very high definition of both lows and highs. This type of setting is bright and clear (with good pickups in your guitar), and optimizes both the “growl” on the lower strings and the “bells” on the high strings.

As stated earlier, the MID frequencies are the key. Turning the MID Frequency control slightly clockwise will reduce highs further.

Once the equalization is set to your satisfaction, the BLEND control can be rocked slowly while striking a wide grip of strings repeatedly to accurately “fine tune” all the EQ settings at one time.

Remember that these controls are sensitive, so a little adjustment can change a lot.

TCA-500C COMBO AMP SETUP SETTINGS: (CONTINUED)
MORE AGGRESSIVE SETTING

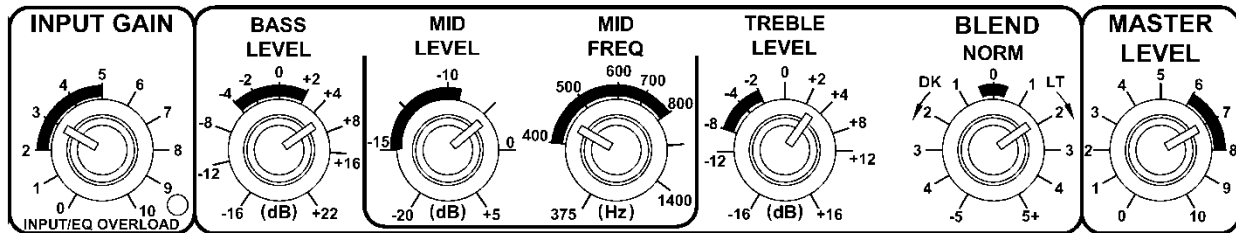

These EQ settings, with only slight variations, are used by a number of professional musicians to “cut through the mix” in live band applications. Sonically, it is designed to “fit” in the “pocket” above the bass and low keyboards and below the strings, providing clarity to the steel without clashing against the other orchestral elements. As such, it may appear brash, or too “out in front” when playing with little or no accompaniment. However in live applications, when used with the proper pickups, cables and volume pedal, it can sit well in the mix and provide a live sound reminiscent of Push-Pull guitars at their best. It is generally fine-tuned by moving the BLEND control plus or minus one mark on the dial either way.

Once the equalization is set to your satisfaction, the BLEND control can be rocked slowly while striking a wide grip of strings repeatedly to accurately “fine tune” all the EQ settings at one time.

Remember that these controls are sensitive, so a little adjustment can change a lot.

ANOTHER FAVORITE SETTING FOR SOME PROFESSIONAL PLAYERS

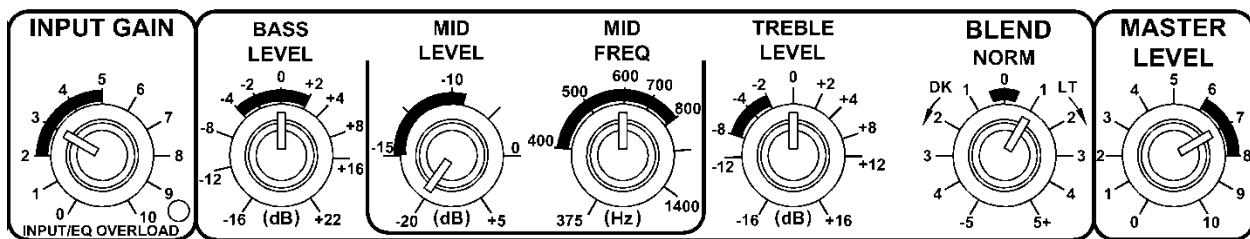

These settings are favored by a number of leading musicians. While projecting well in solo performances, they provide an extremely full bodied sound with bell-like clarity and superb string separation with most pickups.

Once the equalization is set to your satisfaction, the BLEND control can be rocked slowly while striking a wide grip of strings repeatedly to accurately “fine tune” all the EQ settings at one time.

Remember that these controls are sensitive, so a little adjustment can change a lot.

TCA-500C *THERMAL MANAGEMENT SYSTEM*

INTRODUCTION

The cooling system for the TCA-500C Audio Amplifier consists of two variable-speed fans and an intelligent digital controller circuit. The speed of the fans is determined by the temperature at multiple key points within the amplifier. The controller is designed to run the fans at the slowest possible speed sufficient to maintain the amplifier at a safe operating temperature, and thus yield the quietest possible operation. As the temperature of the amplifier increases, the fan speed is increased as necessary.

NORMAL COOLING MODE: TEMPERATURE INDICATION

The amplifier's temperature is indicated on the front panel via the status LED's:

- Green = Temperature is above the Low temperature threshold
- Yellow = Temperature is above the Medium temperature threshold
- Red = Temperature is above the High temperature threshold

The following table shows the state of the Green, Yellow and Red LED's, and the fan speed for the specified temperature ranges:

Temperature		LED Status			Fans	
>=	<	Green	Yellow	Red	No.	Speed
	Low	Wink	off	off	1	Minimum
Low	Medium	ON	off	off	2	Increasing
Medium	High	ON	ON	off	2	Increasing
High		ON	ON	ON	2	Maximum

Notes:
'Wink' = short blink, once per sec.
'ON' = on solid.

FAN SPEED OUT OF SPEC INDICATION

The speed of the fans is measured continuously in order to make sure that the fans are operating properly and to assure adequate cooling for the amplifier. If the speed of any of the fans is out of allowed tolerance for five or more consecutive seconds, then the LEDs defined by the above table (i.e., Green *and* Yellow for temperature between Medium and High) will blink long flashes twice per second; they will be On for ¼ second, and Off for ¼ second. This is a flash that is easily discernible from the 'Wink' condition described above. If the speed of the fans returns back to within tolerance, the blinking will stop, and the LEDs will return to the state described in the table above. Should this 'Flashing' persist, this could be indicative of a fan failure, and could lead to the amplifier overheating. In this case, the amplifier should be returned to the factory for repairs.

TCA-500C THERMAL MANAGEMENT SYSTEM (CONTINUED)

FAN-WEAR BALANCING

In order to further minimize the noise produced by the fans, and to prolong the life of the fans, the fans are controlled individually. Whenever the temperature of the amplifier is below the Low temperature threshold, one of the fans is turned off, and one fan continues to run at the minimum speed. In most environments, when the amplifier is idle or played at lower levels, a single fan is adequate to maintain a desirable temperature within the amplifier. Whenever the amplifier temperature rises above the Low threshold, the second fan is turned on in addition to the first one; therefore, both fans will be running, initially at the minimum speed. Should the temperature of the amplifier continue to rise, the speed of both fans will be increased accordingly; if the temperature of the amplifier drops, the speed of both fans is reduced accordingly. If the temperature of the amplifier again drops below the Low threshold, then the second fan is turned back off. The fan which will 'always be On' is alternated every time that the AC mains power is cycled. Thus, in the long run, the wear on the fans will be balanced.

STUDIO (NO FANS) MODE:

TEMPERATURE INDICATION

To enable the studio mode, turn the Power Amp On/Off switch to the "Off" position. The Power Amp switch is located on the rear panel, just above the AC (Mains) power cord socket.

In the Studio mode, the power amplifier is switched off and the fans are not turned on. In this mode, the LEDs blink a special pattern to alert the user to the fact that the unit is in this mode, the power amplifier is off, and to indicate the temperature of the amplifier. The blink pattern is three (3) short blinks (winks) followed by a short pause, and then repeat. For added visual emphasis, in later model amplifiers, this pattern is supplemented by all three LEDs blinking three (3) times; alternating with the temperature display indication.

The amplifier's temperature is indicated on the front panel via the status LEDs:

Green winking	Temperature is below the Medium temperature threshold
Green and Yellow winking	Temperature is above the Medium temperature threshold
Green, Yellow, and Red winking	Temperature is above the High temperature threshold

FREQUENTLY ASKED QUESTIONS

What's a good setting to start with on the Gain control?

An initial setting of “3” is a good starting point. The Input Gain control delivers plenty of level so be cautious to avoid the red overload (“clipping”) LED from coming on.

What are the frequencies covered by the Mid Freq control? Mid Level?

The “Mid Freq” control has a range from 375 Hz to about 1400 Hz. The range is scaled to values of, 375, 400, 500, 600, 700, 800 and 1400 Hz. The “Mid Level” control adjusts from -20 dB cut at full CCW position to a +5 dB boost at full CW position.

What does the Blend control do?

This control is used as an overall “fine” tone control to be used **only** after setting the other tone controls to your satisfaction. Rotating the knob clockwise yields a brighter more aggressive tone and counterclockwise results in a mellower, warmer tone. Straight up (zero) yields no change.

What's a good setting to start with on the Master Level control?

A setting of “5” is a good place to start. This level will be determined by the size of the room you are playing in. The Master Level control delivers plenty of level so be cautious in its use.

What kind of headphones should I use?

Use low impedance (35-60 ohm) stereo closed or open style depending on personal preference. Sony MDR 7505 headphones are recommended for best fidelity.

Can I drive speakers with the headphone jack?

No, only use it for headphones. It was designed for headphones. The preamp will deliver up to half a watt per channel into eight ohm from its internal stereo headphone amp.

What does the red LED overload indicator show?

The **Overload LED** shows when the preamp enters (or is about to enter) soft clipping. Although you might see it light up on rare occasions, you'll probably never hear the difference. This LED indicates an overload on the input or equalizer circuits. Reduce gain or adjust EQ of input to eliminate blinking.

Tell me about the Tuner Out function.

The Tuner Out jack has a buffer stage and circuitry which isolates the output of the tuner from the rest of the circuitry eliminating a common source of external noise sometimes emanating from some tuners. This circuit will not load down other circuitry in the TCA-500C. The Tuner Out can also be used as an effects Send.

What does the Mute button do?

When engaged, the mute function allows the tuner, headphone amp, and effects send and return to remain On while the preamp out and XLR direct out feed are disabled. This way you can practice at home or in between songs on stage without your power amp On and still get a stereo feed to your headphones complete with stereo effects. Use it to mute your output while changing a string, tuning up, running through upcoming licks or adjusting the effects unit.

FREQUENTLY ASKED QUESTIONS
(CONTINUED)

Will pushing the Mute button send a loud “pop” into my speakers, headphones or the XLR Direct Out (the house feed) when I activate it?

No, the preamp employs silent muting circuitry.

How do I use the Aux In feature?

The Aux In may be used to input stereo rhythm tracks or background music from CD or MP3 players. The Aux In feature can also function like a second stereo effects return. It can be used as a way to inject practice music into the main channels and/or headphones or to add a second effects return. The amount of music or effects level is determined by the output level of the music or effects player and the Aux In Level control. All audio connected to the Aux In is fed to the Direct Output connector for PA and recording purposes.

Can I safely run phantom power into my Direct Out circuit?

While it is not necessary (nor a good idea) to run phantom voltage into the Direct Out connector, it is designed to withstand the IEC specified maximum of 10 milliamps without damage.

What output level can I expect to see from the Direct Output connector?

Normally, the output is approximately the same as the main outputs, up to 5 volts maximum, however it can be controlled by the user in real-time by using the Direct Output control on the front panel. This control allows the DO output to be set from mic level (-30 dBu), to high line level (+4 dBu).

This is very handy when a sound man pre-sets your level on the board too low and leaves for a while. Normally, you would be stuck. By using this control, you can simply reach over, set your house volume through the PA board, and hopefully, not start a “sound war” when he returns to the booth.....

(Optional) *EXTERNAL CONTROL UNITS*

TCA-500C REMOTE UNIT OR FOOTSWITCH FOR USE WITH LEXICON MX-200 EFX UNITS

An External Control Unit which clips on the leg of a pedal steel is available to control the Reverb and TBro effects within the TCA-500C Combo Amplifier, as well as to Enable or Disable the EFX “engines” in the Lexicon MX-200. It provides two toggle switches, one for turning the Reverb On and Off, and a second for turning the TBro effect On and Off.

CONTROLLING THE TCA--500C BUILT-IN EFFECTS

Note that the TBro and Reverb **pushbutton switches** on the front panel of the TCA-500C **must be ON** (pushed in) in order for the remote unit to function.

These switches are located on the right side of the box as viewed from the player’s position. The TBro On/Off switch is positioned on the upper right corner of the front panel.

The Reverb On/Off switch is positioned on the lower right corner of the front panel.

A ¼ inch TRS stereo cable is required to connect the TCA-500C side of the Control Unit to the “Foot Switch” jack on the rear panel of the TCA-500C. This cable is identified by a white ring around the cable directly behind the TRS stereo plugs on both ends. Always be sure the cable with the white ring markings is fully inserted into the bottom right side of the Control Unit, with the TRS stereo plug on the other end plugged into the Foot Switch jack on the rear panel of the TCA-500C.

One way to remember this is to recall the rhyme used by cardiac technicians in hospitals for their EKG leads:
“White on the Right”.

(NOTE: A two-button foot pedal switch is also available from Telonics which accomplishes the same remote switching functions for the TCA-500C. A single ¼ inch TRS stereo cable is used to connect the foot pedal switch unit to the Foot Switch jack on the rear panel of the TCA-500C.)

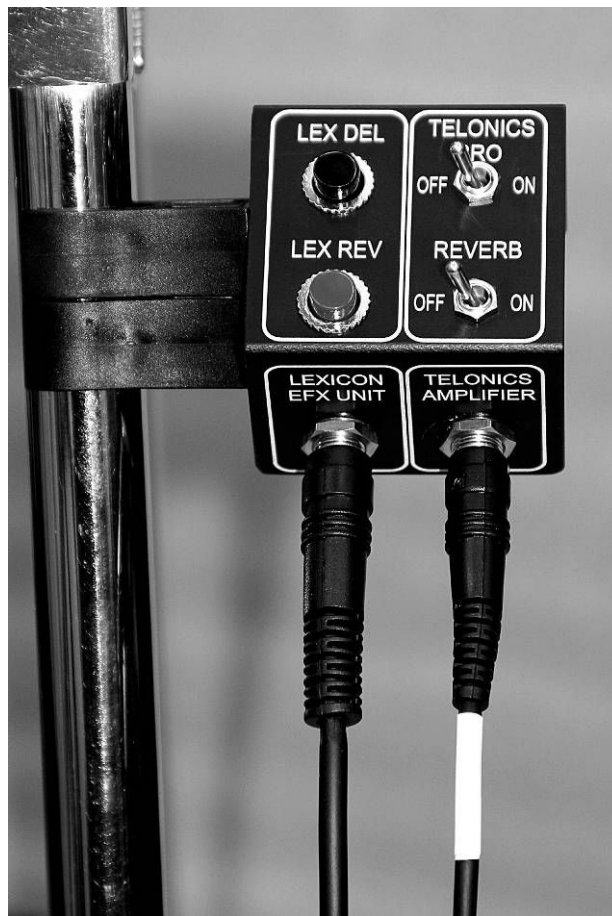

(OPTIONAL) EXTERNAL CONTROL UNIT (CONTINUED)
CONTROLLING THE LEXICON MX-200

The External Control Unit provides two (2) momentary push button switches which may be used to either ENABLE (UN bypass), or DISABLE (bypass) the two effect “engines” in the Lexicon MX-200 effects unit.

A second ¼ inch TRS stereo cable is required to connect the Lexicon MX-200 side of the External Control Unit (the LEFT side). The cable for this connection is all black in color. Be sure this cable is fully inserted into the bottom LEFT side of the Remote Control Unit, with the TRS stereo plug on the other end of the cable plugged into the FOOTSWITCH jack on the left side of the rear panel of the MX-200 EFX unit.

The two ¼ inch TRS stereo cables used for connection are available from Telonics.

Momentarily depressing these two buttons does exactly the same thing as depressing the two BYPASS buttons on the front panel of the MX-200. You can determine the status by looking at the LED indicators within the BYPASS buttons on the MX-200.

The controls for the two (2) effects processors in the MX-200 are grouped together in adjacent rectangular “boxed” areas on the front panel of the MX-200. Each “box” contains a BYPASS button in the upper right corner, three control/function/parameter knobs, a tempo button and a UP/DOWN toggle switch which is used to select the desired effect (which that particular processor “engine” will be generating.

Processor Number 1 is on the LEFT. Its BYPASS button has a GREEN LED in it. This processor is normally used to generate DELAYS and similar effects.

Processor Number 2 is on the RIGHT. Its BYPASS button has a RED LED in it. This processor is normally used to generate REVERBS and similar effects.

NOTE!

It is necessary to comprehend that when the LED in a given BYPASS button is ON, that processor is BYPASSED, meaning that the effect being generated by that process is OFF! I.E., when a given BYPASS button LED is ON, the effect is OFF!

The two buttons on the LEFT side of the External Control Unit control these BYPASS buttons just as if you actually pushed the buttons on the MX-200 themselves. The STATUS of the BYPASS buttons (and therefore the status of the effects processors in the MX-200) is indicated by the colored LED within the button on the MX-200.

The UPPER/BLACK button on the External Control Unit controls Processor #1 (Green BYPASS LED on the MX-200).

The LOWER/RED button on the External Control Unit controls Processor #2 (RED BYPASS LED on the MX-200).

***(OPTIONAL) EXTERNAL CONTROL UNITS
HANDY PATCH MIDI CONTROLLER MC100***

The Handy-Patch can be attached to the leg of a steel guitar using the Mounting Bracket and Swivel accessory as shown in the photos.

The Handy-Patch (HP) is an industry first, special purpose, MIDI controller designed specifically to interface the steel guitar player with MIDI-enabled effects processors mounted in the 1U rack space of the Telonics TCA-500 series combo and head-only amplifiers.

It is supplied in the form of a small box which mounts quickly and easily on the leg of a steel guitar and is connected by a dedicated MIDI cable assembly to the TCA-500 amplifier and the effects processor (which has been previously programmed with a selection of combined effects). These effects may be instantly called up/'loaded' by selecting a 'preset' number (note that a 'preset' may also be referred to as a 'patch' or 'program change').

The Handy Patch uses the music industry standard MIDI connection to send information to the effects processor. A display on the front indicates the number of the preset which has been selected. Two push-buttons allow the Present number to be increased, decreased or rapidly scrolled up and down.

Two Additional buttons allow two Fast-Presets to be selected. When a Fast-Preset is selected, the unit instantly calls up a previously selected preset. When that same Fast-Preset button is pressed again, it instantly returns to the originally selected preset. For example; when used with the TC Electronics G-Major 2 effect processor, this allows the player to instantly toggle from the current preset to the TBro effect preset rapidly within the performance and back again.



(OPTIONAL) EXTERNAL CONTROL UNITS (CONTINUED)
HANDY PATCH MIDI CONTROLLER MC100

A third Fast-Preset can be selected by using an optional (not supplied) momentary contact footswitch which can be plugged into the Handy Patch. This allows a predetermined effect patch to be selected and de-selected (toggled), without the player needing to take his or her hands away from the instrument.



In addition to sending the MIDI Preset information, *the HP can also control parameters within the effects processor using the Control Change (CC) knob/wheel on the front panel.*

For example; when used with the G-Major 2 effects processor, this allows the player to control the effect level of the preset selected and change that level during the performance. In addition, the CC knob value can be stored by simply pressing the knob so that the next time that preset is called up; it will have the stored effect level applied.

Note: The Handy-Patch can also be used with the Lexicon MX-200 effects unit and by using defaults, will select presets when the Lexicon MX-200 has been set to MIDI channel 1. (The HP transmits commands on MIDI channel 1, so the MX-200 must also be set to channel 1.) The CC Knob can also be programmed to access the available control change functions if required.

Note: the CC function can be disabled if the user prefers not to use this control or finds it confuses their effects unit of choice.

Accessories available for a Handy-Patch system:

- 1) Handy-Patch MIDI Controller - model MC100
- 2) Handy-Patch to TCA-500C 7-pin MIDI cable assembly – MC100/7PIN-LEAD1
- 3) Mounting bracket and Swivel Assembly
- 4) Footswitch, Fast Preset 3 – Not yet available

***(OPTIONAL) EXTERNAL CONTROL UNITS (CONTINUED)
HANDY PATCH MIDI CONTROLLER MC100***

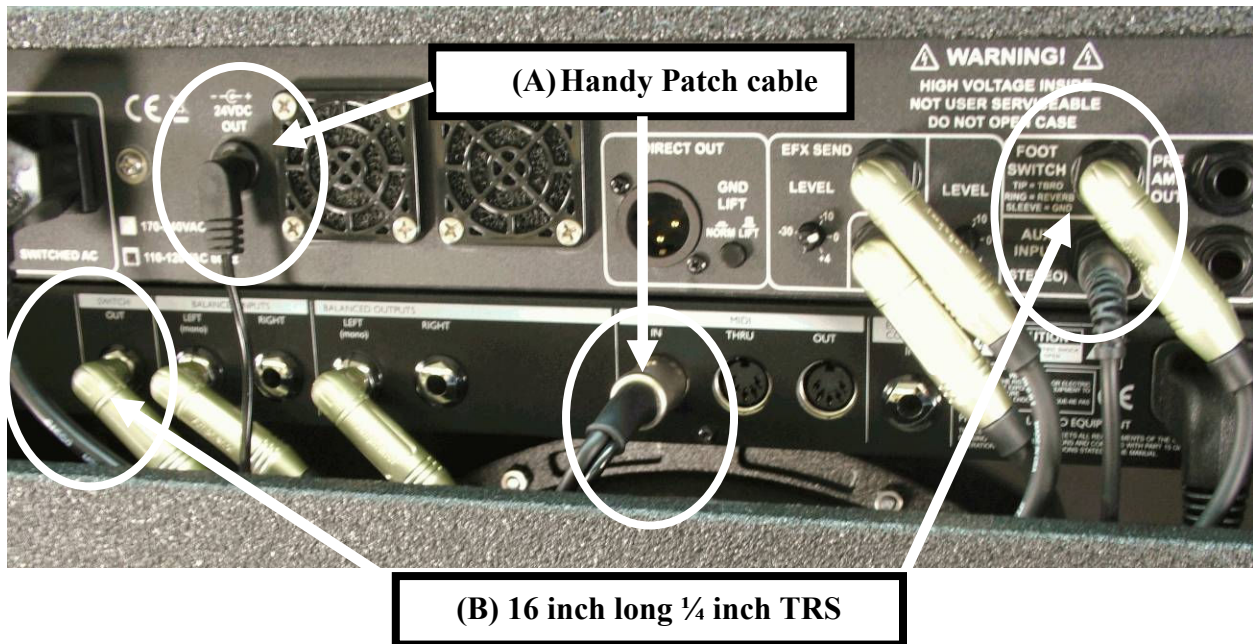

- A) The Handy Patch comes with a cable (A above) to connect to the TCA-500C. On one end is a five pin DIN connector with a pigtail power connector. This five pin DIN connects to the G-Major 2 MIDI IN jack. The pigtail power connector should be plugged into the 24VDC jack as shown in the picture above. The other end of the cable has a seven pin DIN connector that plugs into the Handy Patch. The Handy Patch will now turn on when the TCA-500C is powered up.
- B) The G-Major 2 has a Switch Out jack on the back that uses internal relays to switch the Tip or the Ring terminal on the jack to the Sleeve (ground). This output will allow the G-Major 2 to control the Foot Switch input jack on the TCA-500C, which controls the internal Reverb and TBRO effects. A 1/4 inch TRS cable (B above) should be connected between the Switch Out jack on the G-Major 2 and the Foot Switch jack on the TCA-500C as shown in the picture above.

NOTE: See the Handy Patch User's Manual for more detailed information.

USING SMALL “STOMP BOX” EFFECTS UNITS WITH THE TCA-500 SERIES AMPLIFIERS

TCA-500 MINI-COMBO MODELS

The Telonics TCA-500 Mini-Combo amplifiers do not offer a 1U rack space in order to conserve weight and space. They are equipped with minimal internal effects.

It is therefore sometimes desirable to add one or more additional effect(s) using small, special purpose 9 Volt “Stomp-Box” effects units. A proper series mode insert for connecting such effects units is provided in the form of the “Pre-EQ” Insert/Pedal Loop on the rear panel.

In addition, a dedicated 9 Volt power supply is included in the TCA-500 Mini-Combo Amplifiers specifically for this purpose. The EFX power jack is located on the rear panel of the amplifier. It provides 9 Volts DC, at up to 1amp (1,000 mA). The jack is wired in accordance with the stomp box de facto standard; CENTER PIN IS NEGATIVE (-), outer barrel positive (+).

ALWAYS check the polarity required by your external effects unit before plugging it into power.

By using the stomp boxes in this manner, the user is able to connect his/her guitar’s signal directly to the input of the TCA-500 Amplifier and enjoy the clarity and string separation provided by the internal studio grade preamplifier, as well as, to establish the noise figure prior to introducing the processing propagation time loss and A/D & D/A conversion noise inherent in such stomp boxes.

Most “Stomp box” or effects “pedal” units should be connected using the “Pre-EQ Insert”/Pedal Loop on the rear panel of the TCA-500 series amplifiers. Such effects units are of the type; BOSS RV3, RV5, Strymon DIG, Digitech Polara, Holy Grail, Holy Grail Nano, Strymon Flint, TC Electronic Hall of Fame Reverb, Mr. Springy, Z-Cat, etc.

To connect a single 9Volt “stomp box”:

First, connect a short ¼ inch TS cable from the SEND output to the INPUT of the effects unit. (If you are using a STEREO effects unit, use the MONO jacks.)

Then using a second short ¼ inch TS cable, connect the OUTPUT of the effects unit to the RETURN jack of the Pre-EQ Insert.

When all signal connections have been made and checked, connect the effects unit to the (-) 9 V power jack on the rear panel of the TCA-500 Mini-Combo amplifiers.

If you wish **to connect more than one 9 Volt effects unit**; for example, delay, followed by reverb, you may connect multiple units in series within the Pre-EQ Insert Loop.

To do so, connect a short ¼ inch TS cable from the SEND output of the Pre-EQ Insert to the INPUT of the first effects unit. (If you are using one or more stereo effects unit, use the MONO jacks.)

Then using a second very short ¼ inch TS cable, connect the OUTPUT of the first effects unit to the INPUT of the second effects unit.

Last, using a third short ¼ inch TS cable, connect the OUTPUT of the second effects unit to the RETURN jack of the Pre-EQ Insert.

When all signal connections have been made and checked, connect the (-) 9 V power jack on the rear panel of the TCA-500 Mini-Combo amplifiers to the effects pedal using the provided power cable.

Note that some “Stomp Box” effects pedals are designed to accept only very low-level signals (such as guitar output only). Such units must therefore be installed between the user’s volume pedal and the input of the TCA-500 amplifier. Overdrive – Type Stomp pedals are typically installed in this manner.

NOTE:

All of the above and similar “pedals” are designed for “series” connection. This means that they mix together in varying degrees, the original “dry” sound of your guitar, with the “wet” or processed sound (reverb, delay, etc.).

As such, they MUST be used in the Pre-EQ Insert Loop and are NOT SUITABLE to be inserted in a Parallel Effects Loop.

To be suitable for use in a parallel effects loop, an effects unit must have a fully PARALLEL mode, which means that it is FULLY WET – no dry sound must be allowed to pass through, at all. (If any dry signal is passed through such an effects unit, it is delayed due to the digital processing time required by the analog-to-digital and the digital-to-analog converters within the effects unit – it’s just a fact of life, it takes a certain amount of time to do these necessary conversions.

Then, when this delayed dry signal is mixed back with the pristine, clean dry signal which was not sent out to the effects unit, phase cancellation occurs at various frequencies, which forms a “comb” filter whose peaks and nulls are a function of the delay required in each individual delay unit (so it will vary from unit to unit).

The resultant sound can vary from OK to horrible, depending on the effects unit and the frequencies played through the amplifier.

That is why all high-end effects are set to “parallel mode” only, and connected to the parallel effects loop of studio equipment, and the TCA-500 series amplifiers.

“Fully wet” stomp boxes” may” be available; however after testing many, we are not aware of even one we can recommend at this time.

TCA-500 COMBO AND HEAD-ONLY MODELS

Normally, small stomp box effects units are not used with TCA-500 Combo and Head-only Amplifiers since they are provided with a 1U rack space to accommodate full-on professional effects units and the Handy-Patch remote MIDI controller.

Nonetheless, in the event that the user wishes to stomp box effects units with these models, they should be connected in the manner described above for the TCA-500 Mini-Combo Amplifiers.

However, the user must be aware that these models DO NOT provide a 9 VDC power source for stomp box effects units. Rather, they offer 24 VDC for the Handy-Patch remote MIDI controller. (This 24 VDC output jack may alternatively be used as a second power source for Telonics model FP-100 foot volume pedals.)

NOTE that the 24 VDC output jack on these models is wired CENTER PIN POSITIVE (+), outer barrel negative (-).

HOW TO BE A TONE MASTER – SUBTRACTIVE EQUALIZATION

The following information from the great audio engineer John LeMay is an important and insightful key to achieving well-balanced sound with ideal tone.

How to Be a Tone Master by John LeMay

This is a collection of thoughts on how to get the best tone you can through what might seem to be an unconventional way of doing it. This information comes from my years of mixing and mastering experience in Hollywood.

Subtractive equalization: The Art of attenuating, rather than boosting, frequencies to achieve equalization.

When first trying to get "that sound", your tendency may be to push something up. Where you might feel like you need to add some high end, you may actually just need to cut at 200Hz to clear the sound up. Then you can add a dB or two at the top end, and it will sound as open as adding 6dB or 8dB of high-frequency EQ.

Excessive EQ can mask perception of audio nuance and detail. When frequency buildup becomes extreme — particularly in the upper midrange, where the ear is most sensitive — subtle space-enhancing details are the first to fall victim to frequency masking and hearing fatigue. As more additive EQ (boosts as opposed to cuts) gets piled on, the final result is often grating, tinny, or downright unlistenable at moderate volume. Such an excessive buildup — in addition to hastening listening fatigue — may smear or obscure subtler aspects you're playing. The interaction of compression or reverb in this range further compounds the problem.

EQ should almost always be used as a subtractive device. That means, use it primarily for lowering certain frequencies in a pre-amp. Every mix or amp sound usually has too much of something to begin with." Too much bottom end, too many high's, mids are honkin'. Use EQ to lower those trouble spots. Result . . . Cleaner sound, better sound. Simple, isn't it? EQ should be subtle - not drastic. Boosting the EQ also has a tendency to raise the noise floor.

In subtractive EQing you are pulling down the level of a given frequency. In additive EQing you are raising the level of the chosen frequency. For example, say you're in the studio and you have an acoustic guitar track that sounds too "muddy". Your first instinct may be to raise the frequencies around 4kHz to brighten up the sound a bit. But you are better off pulling down the low-mid frequencies around 325Hz instead!

Here's a simplistic example of how to do it. Say you want more high-end. First bring down the low end a bit, and then raise the overall (master) gain to compensate for the gain loss. This has the effect of raising the high end but without increasing noise. Go back and forth between lowering the bottom end and replacing gain with the master level control till you achieve the tone you are looking for. Practice this till it becomes second nature. Raising the bottom end is done in much the same way. First bring down the high end a bit, and then raise the overall (master) gain to compensate for the gain loss. This effectively raises the bottom end EQ. This requires careful listening to know how much to cut and how much master gain to compensate with.

***HOW TO BE A TONE MASTER – SUBTRACTIVE EQUALIZATION
CONTINUED***

For midrange, I cheat a bit and boost it slightly in the frequency I wish to affect. I then lower the high and low EQ till I achieve the midrange sound I am looking for. A little goes a long way. Practice, practice, practice.

Watch out for the low end. Too much energy in the bottom octaves (below 300 Hz) will mask the higher frequencies and cause you to want to add more highs. You'll end up chasing your tail running after the perfect tone.

When it comes to using EQ, "Less is more".

TELONICS TILT-BACK FOOT

A special Telonics – designed Tilt-Back Foot is provided on the following Models:

TCA-500B&C & Combo Amps

TCA-500B&C Mini-Combo Amps

External Speaker Cabinets for TCA-500B&C Mini-Combos

The Tilt-Back Foot is designed to tilt the amplifier slightly backward to enhance visibility of the control panel. To deploy the Foot, rock the amplifier backward and pull downward on the tip of the foot until it locks into place.

To retract the foot, rock the amplifier backward sufficiently to remove any weight on the foot. Push the tip of the Foot back and upward until it is heard to snap into its cavity on the bottom of the amplifier cabinet.

Do Not Attempt to Stand on the Amplifier Cabinet with the Foot Deployed!

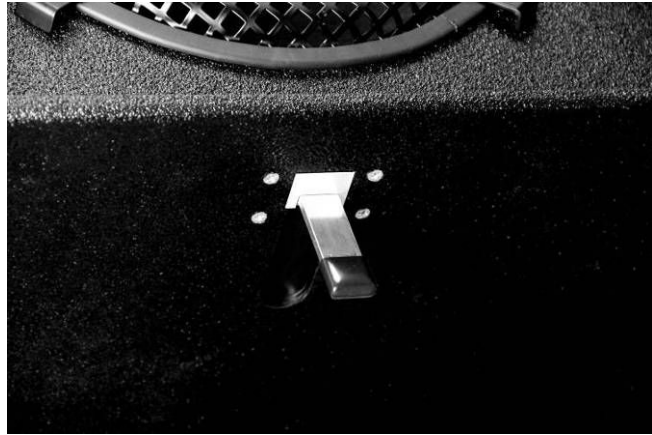

MECHANICAL DATA

Feature	Specification
Electronics Chassis Material	Hard Anodized Aluminum
Front & Rear Panel Markings	Lexan Surface
Cabinet	The cabinet is made from multi-ply Baltic Birch, 12mm & 15mm thick continuous panels that are dove tailed together for maximum strength. Then sprayed with urethane to make a hard, extremely durable finish.
Dimensions	See Outline Drawing page
Total weight	TCA-500C Combo – 34.2 lb. (15.513 kg) With 15 inch speaker & No 1U external effects unit TCA-500C Mini-15 Combo – 33.7 lb. (15.286 kg) With 15 inch speaker TCA-500C Mini-12 Combo - 28.6 lb. (12.973 kg) With 12 inch speaker TCA-500C Head Unit – 12.8 lb. (5.806 kg)

ELECTRICAL DATA

Parameter	Condition	Value
Mains input voltage US Model	115 V ac setting (factory set)	85 V ac to 132 V ac
Mains input voltage Export Model	230 V ac setting (factory set)	170 V ac to 250 V ac
Mains fuse	115 V ac and 230 V ac setting	8 A 250 V ac 5x20mm Ceramic Slow Blow fuse.
Auxiliary switched AC power outlet fuse	115 V ac and 230 V ac setting	2 A 250 V ac 5x20mm glass Slow Blow fuse
Auxiliary switched AC power outlet	115 V ac US Model	NEMA 5-15R
Auxiliary switched AC power outlet	230 V ac Export Model	IEC-320 C-13
Preamp Gain	1 kHz sine	58 dB typical
Power Amp Gain	1 kHz sine	30 dB typical
Output power @ 1%THD+N	$R_L = 4 \text{ Ohm}$ 20 Hz < f > 20 kHz, both channels driven 115 V ac	300 W rms typical
Output power @10%THD+N (Max power 500 W)	$R_L = 4 \text{ Ohm}$ 20 Hz < f > 20 kHz, both channels driven 115 V ac	400 W rms typical

TCA-500C 15-1U COMBO
MECHANICAL OUTLINE DRAWINGS

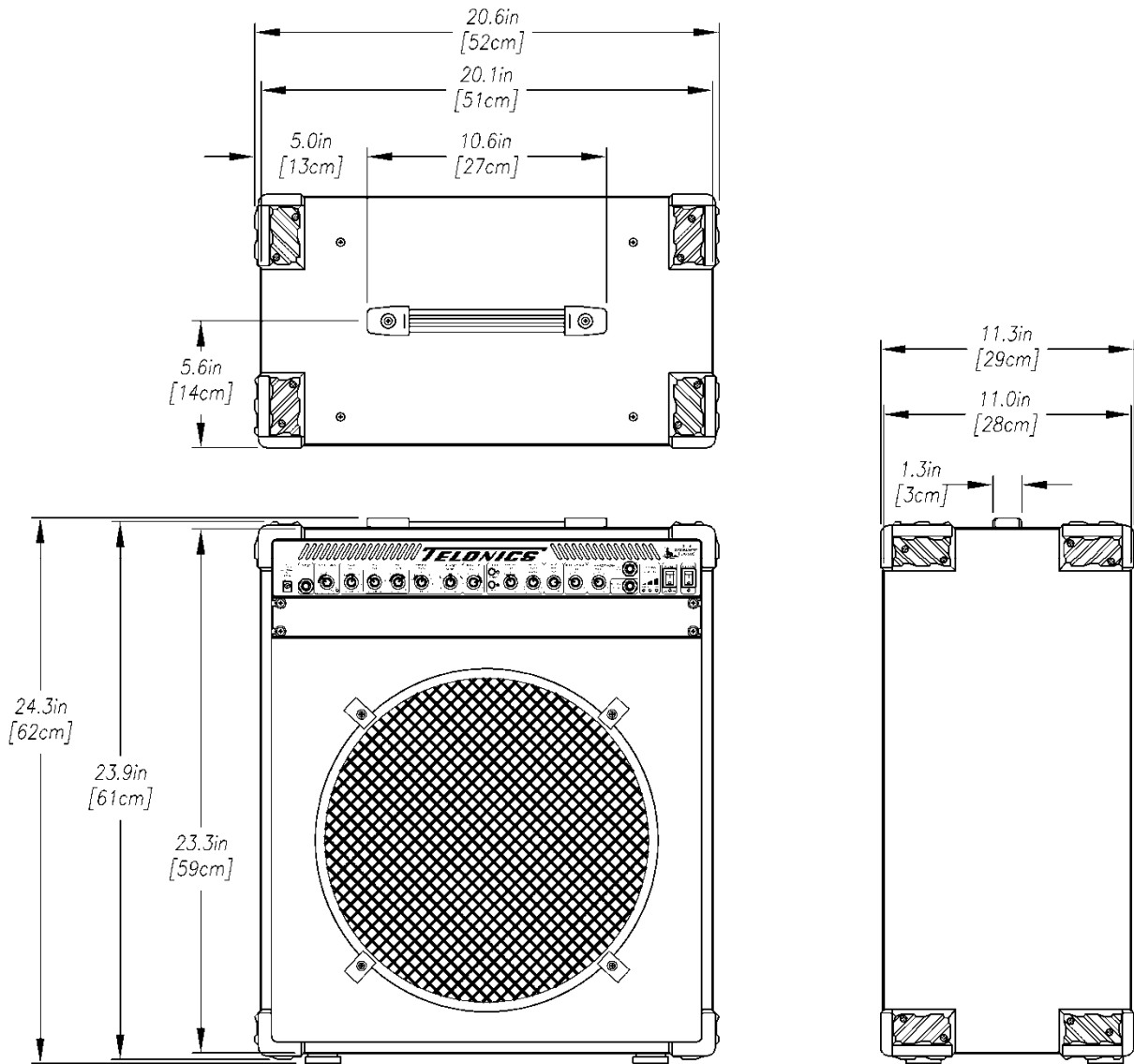

*ALL DIMENSIONS ARE IN INCHES [CM] AND ARE NOMINAL

TCA-500C 12-1U COMBO
MECHANICAL OUTLINE DRAWINGS

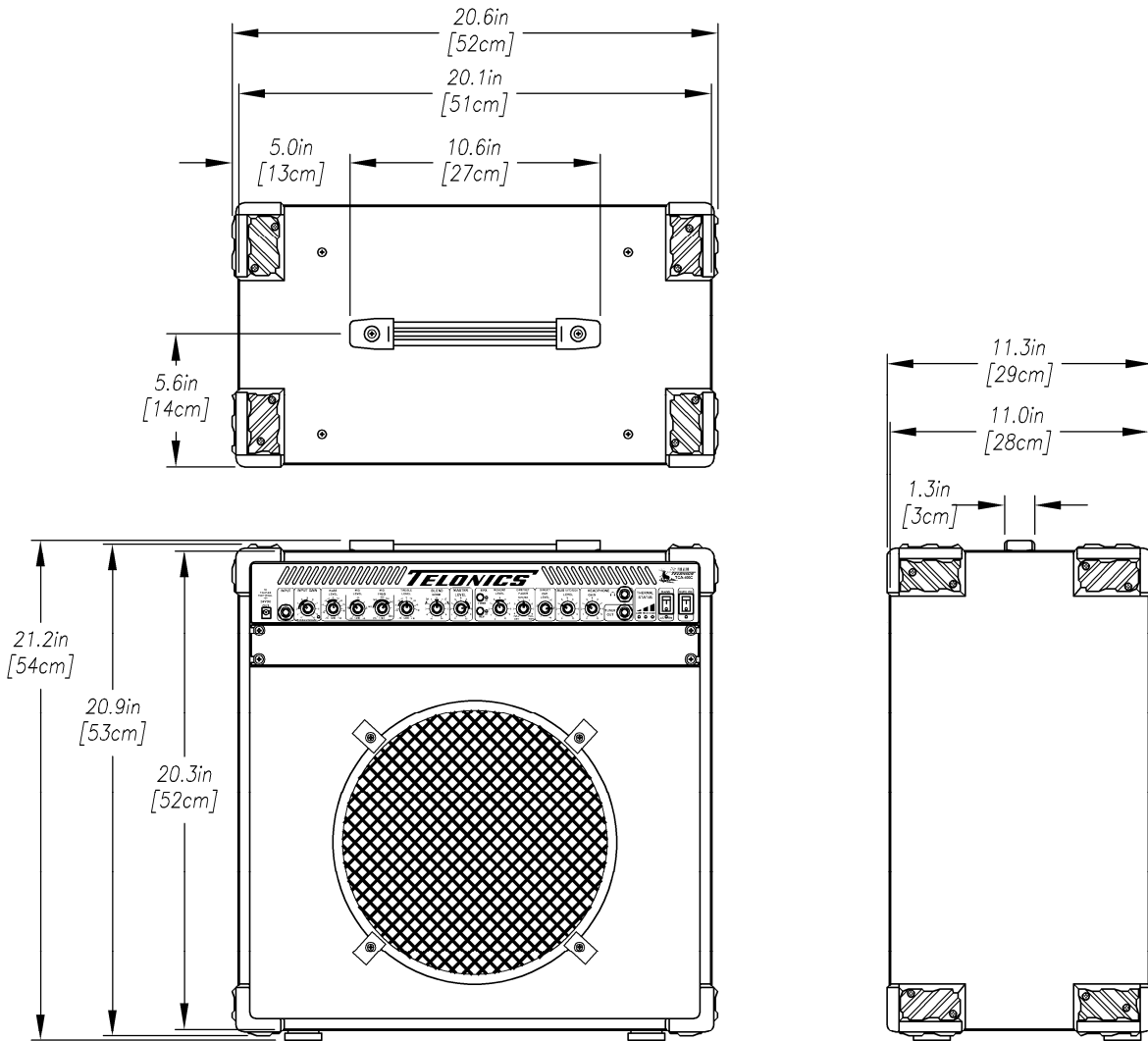

*ALL DIMENSIONS ARE IN INCHES [CM] AND ARE NOMINAL

TCA-500C 15-MINI COMBO
MECHANICAL OUTLINE DRAWINGS

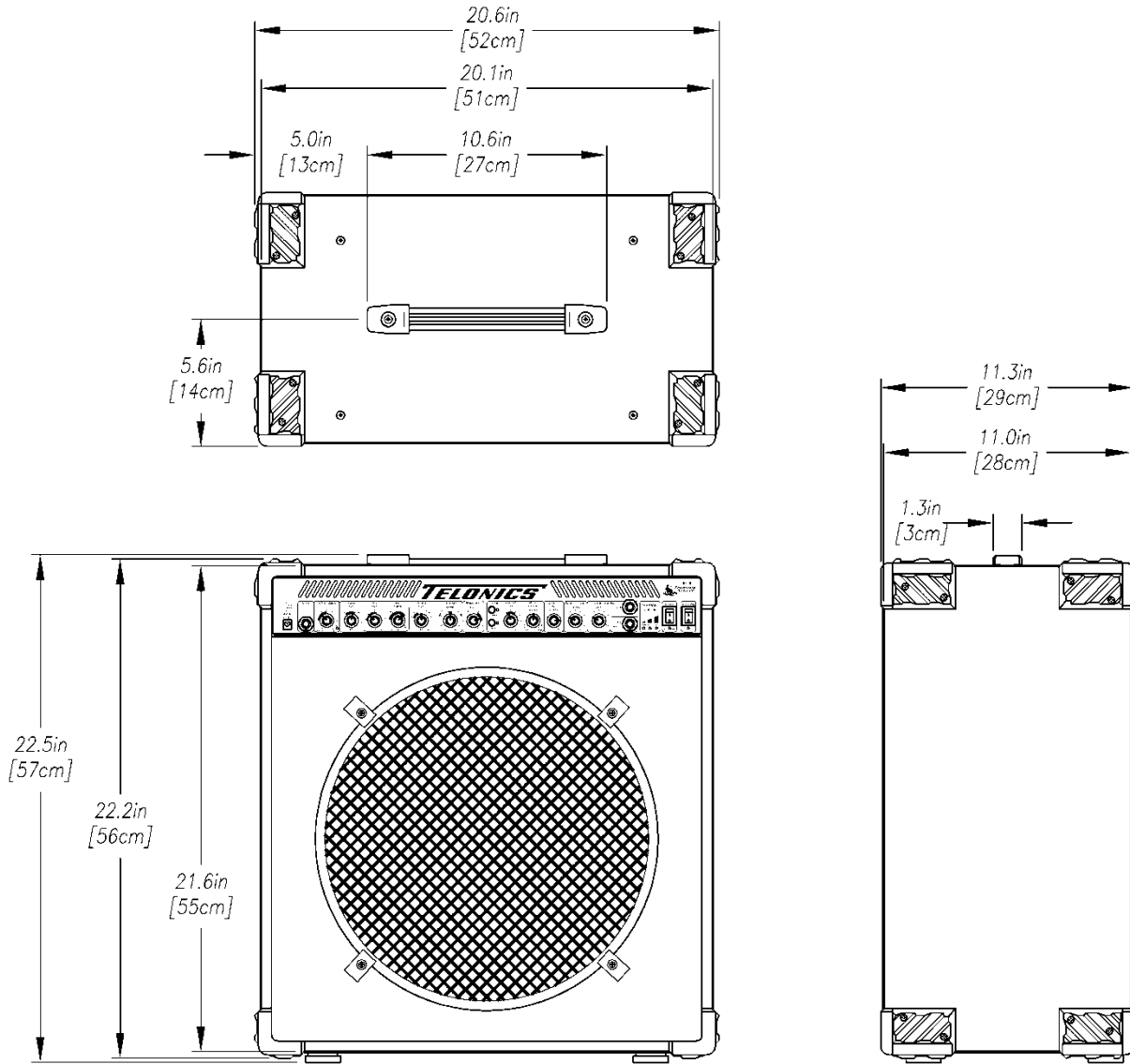

ALL DIMENSIONS ARE IN INCHES [CM] AND ARE NOMINAL

TCA-500C 12-MINI COMBO
MECHANICAL OUTLINE DRAWINGS

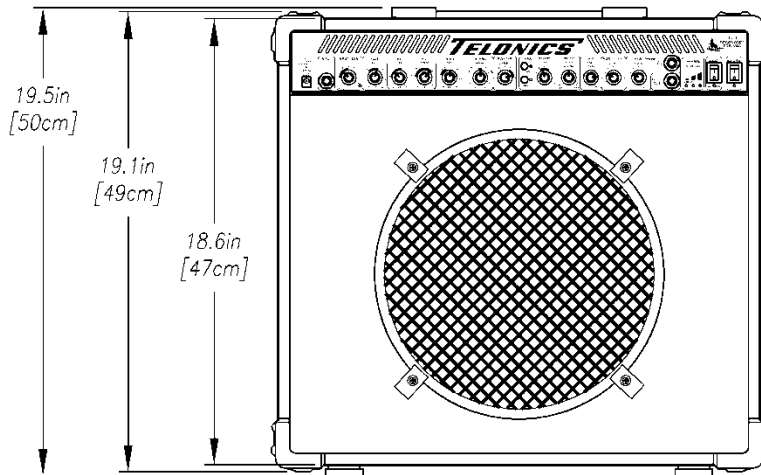
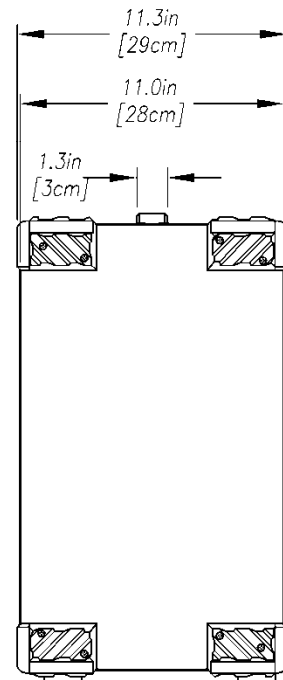
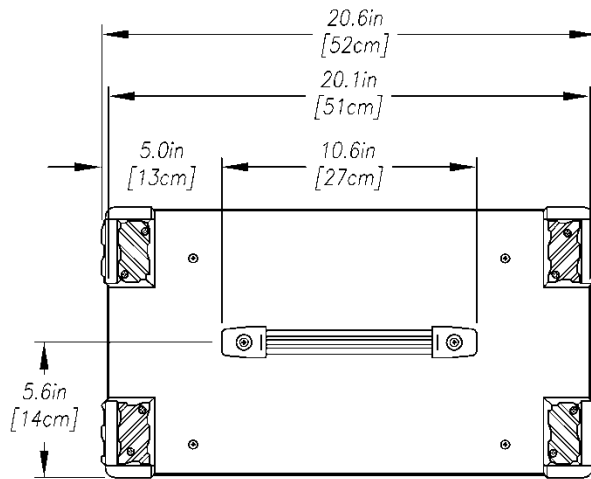

ALL DIMENSIONS ARE IN INCHES [CM] AND ARE NOMINAL

**MINI-15 EXTERNAL SPEAKER ENCLOSURE
MECHANICAL OUTLINE DRAWINGS**

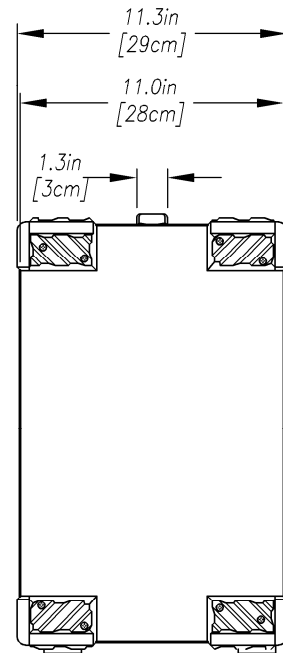
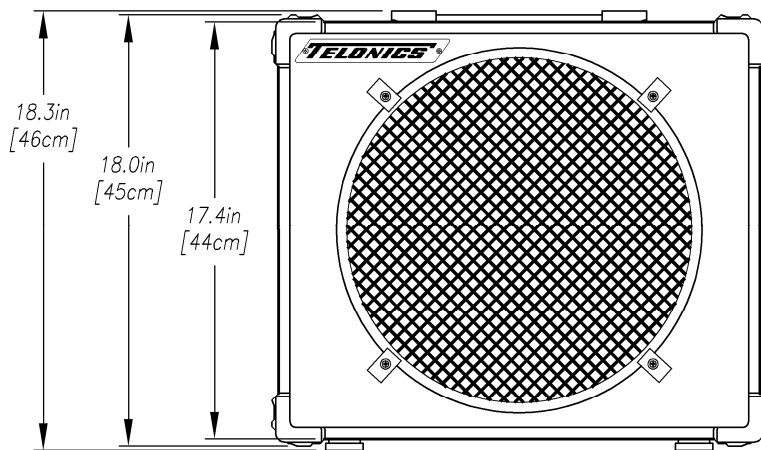
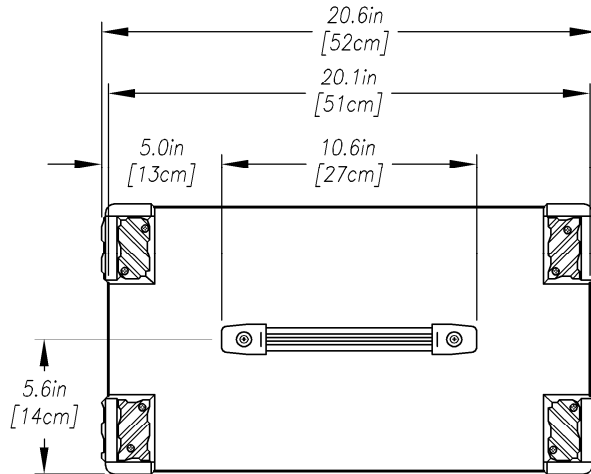

ALL DIMENSIONS ARE IN INCHES [CM] AND ARE NOMINAL

**MINI-12 EXTERNAL SPEAKER ENCLOSURE
MECHANICAL OUTLINE DRAWINGS**

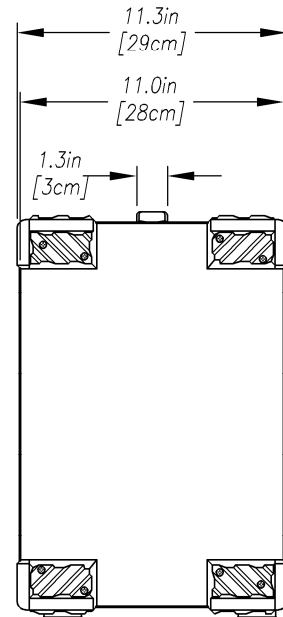
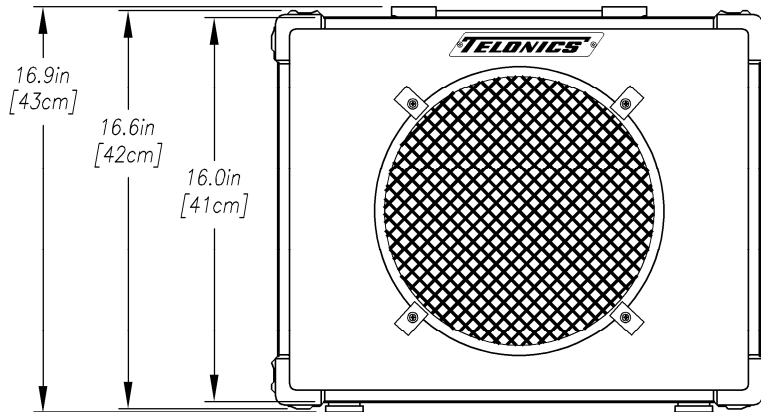
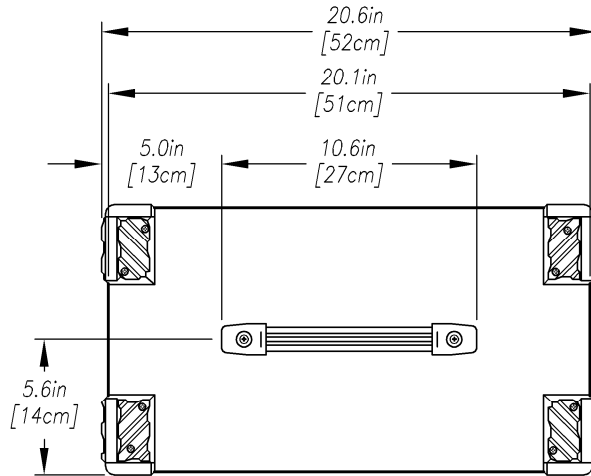

ALL DIMENSIONS ARE IN INCHES [CM] AND ARE NOMINAL

TCA-500C 212 SUPER TWIN COMBO
MECHANICAL OUTLINE DRAWINGS

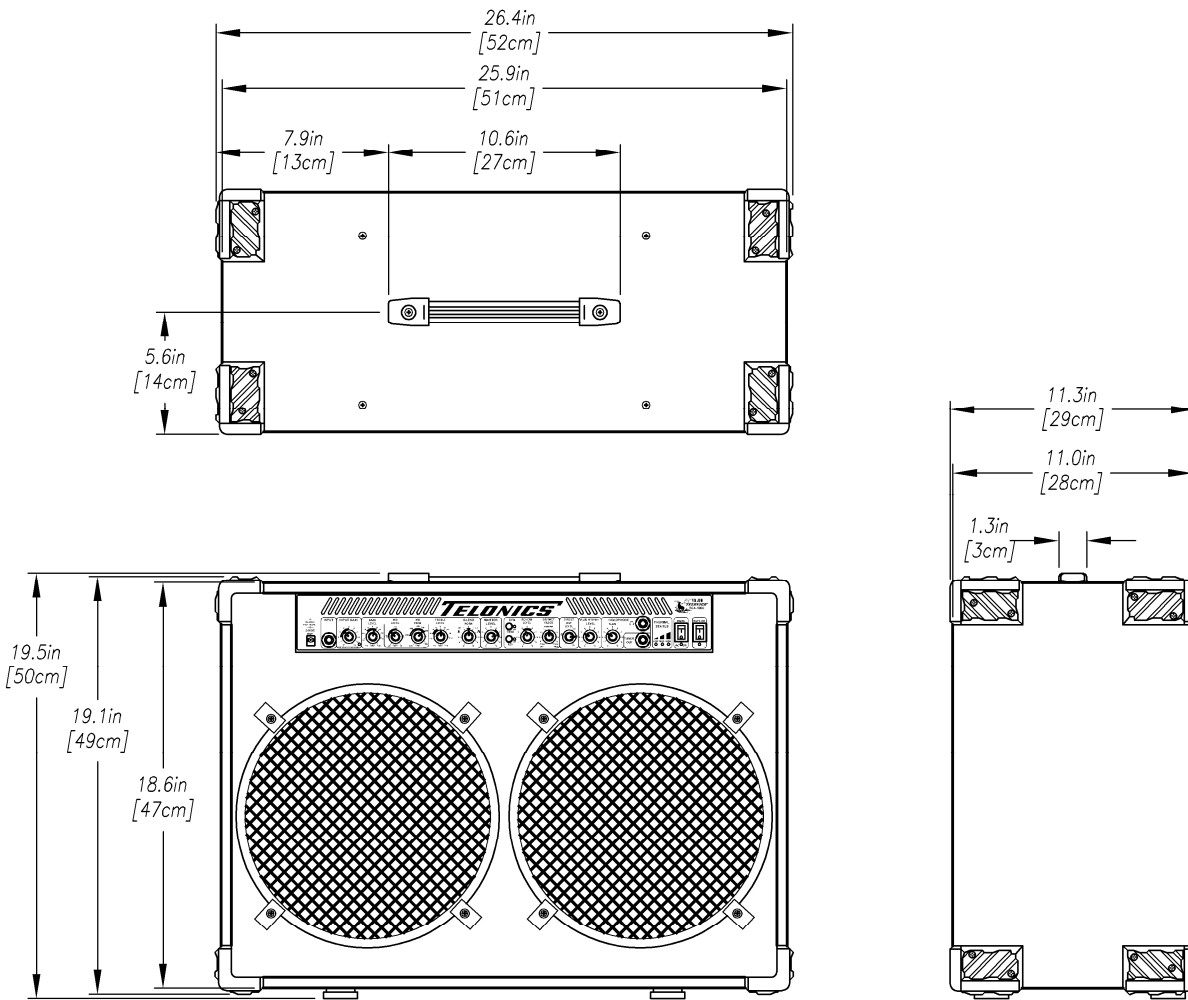

ALL DIMENSIONS ARE IN INCHES [CM] AND ARE NOMINAL

TCA-500C-1U HEAD UNIT

MECHANICAL OUTLINE DRAWINGS

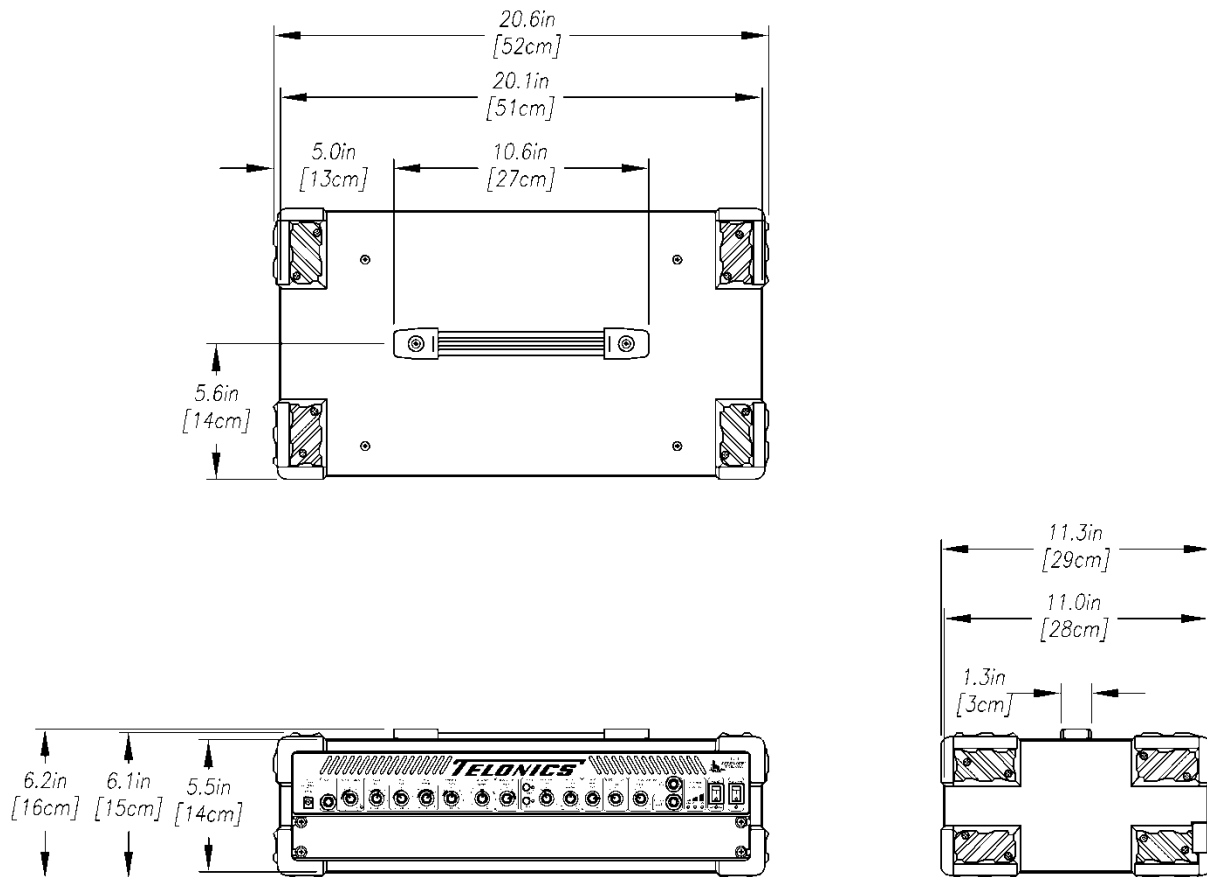

ALL DIMENSIONS ARE IN INCHES [CM] AND ARE NOMINAL

**TLF-PRE500 LITE-FLIGHT PREAMPLIFIER SYSTEM
MECHANICAL OUTLINE DRAWINGS**

